

TAS5342LDDV6EVM

This user's guide describes the operation of the evaluation module for the TAS5342L Digital Amplifier Power Output Stage using TAS5086 Digital Audio PWM Processor from Texas Instruments. The user's guide also provides measurement data and design information like schematic, bill of materials, and printed-circuit board layout.

Contents

1	Overview	3
1.1	TAS5342LDDV6EVM Features	4
1.2	PCB Key Map	6
2	Quick Setup Guide.....	6
2.1	Electrostatic Discharge Warning.....	6
2.2	Unpacking the EVM	7
2.3	Power Supply Setup.....	7
2.4	Speaker Connection.....	7
2.5	GUI Software Installation	7
3	Protection	8
3.1	Short-Circuit Protection and Fault-Reporting Circuitry	8
3.2	Fault Reporting.....	8
4	TAS5342LDDV6EVM Performance	9
4.1	THD+N vs Power (SE $-3\ \Omega$).....	11
4.2	THD+N vs Power (SE $-4\ \Omega$).....	11
4.3	THD+N vs Power (BTL $-4\ \Omega$)	12
4.4	THD+N vs Power (BTL $-8\ \Omega$)	12
4.5	THD+N vs Frequency (SE $-3\ \Omega$).....	13
4.6	THD+N vs Frequency (SE $-4\ \Omega$).....	13
4.7	THD+N vs Frequency (BTL $-4\ \Omega$)	14
4.8	THD+N vs Frequency (BTL $-8\ \Omega$)	14
4.9	FFT Spectrum With -60 -dBFS Tone (SE)	15
4.10	FFT Spectrum With -60 -dBFS Tone (BTL).....	15
4.11	Idle Noise FFT Spectrum (SE)	16
4.12	Idle Noise FFT Spectrum (BTL)	16
4.13	Channel Separation	17
4.14	Frequency Response (SE).....	17
4.15	Frequency Response (BTL).....	18
4.16	High-Current Protection (SE)	18
4.17	High Current Protection (BTL)	19
4.18	Pop/Click (SE)	19
4.19	Pop/Click (BTL).....	20
4.20	Output Stage Efficiency	20
5	Related Documentation from Texas Instruments	21
5.1	Additional Documentation	21
Appendix A	Design Documents	22

List of Figures

PurePath Digital, Equibit are trademarks of Texas Instruments.
Windows is a trademark of Microsoft Corporation.
I²S, I²C are trademarks of Philips Corporation.

1	Integrated PurePath Digital™ Amplifier System	5
2	Physical Structure for the TAS5342LDDV6EVM (Approximate Layout).....	6
3	TAS5086 GUI Window	8
4	THD+N vs Power (SE $-3\ \Omega$).....	11
5	THD+N vs Power (SE $-4\ \Omega$).....	11
6	THD+N vs Power (BTL $-4\ \Omega$)	12
7	THD+N vs Power (BTL $-8\ \Omega$)	12
8	THD+N vs Frequency (SE $-3\ \Omega$).....	13
9	THD+N vs Frequency (SE $-4\ \Omega$).....	13
10	THD+N vs Frequency (BTL $-4\ \Omega$)	14
11	THD+N vs Frequency (BTL $-8\ \Omega$)	14
12	FFT Spectrum With -60 -dBFS Tone (SE)	15
13	FFT Spectrum With -60 -dBFS Tone (BTL).....	15
14	Idle Noise FFT Spectrum (SE)	16
15	Idle Noise FFT Spectrum (BTL)	16
16	Channel Separation.....	17
17	Frequency Response (SE).....	17
18	Frequency Response (BTL).....	18
19	High-Current Protection (SE)	18
20	High-Current Protection (BTL).....	19
21	Pop/Click (SE)	19
22	Pop/Click (BTL).....	20
23	Output Stage Efficiency	20

List of Tables

1	TAS5342LDDV6EVM Specification	3
2	Recommended Supply Voltages.....	7
3	TAS5342L Warning/Error Signal Decoding	9
4	General Test Conditions	9
5	TAS5086 Register Settings.....	9
6	Electrical Data	9
7	Audio Performance.....	10
8	Thermal Specification.....	10
9	Physical Specifications	10
10	Related Documentation From Texas Instruments	21

1 Overview

The TAS5342LDDV6EVM PurePath Digital™ customer evaluation module (EVM) demonstrates the integrated circuits TAS5342LDDV and TAS5086DBT from Texas Instruments (TI).

The TAS5342LDDV is a high-performance, integrated stereo Digital Amplifier Power Stage designed to drive 4-Ω speakers at up to 100 W per channel. The device incorporates TI's Equibit™ technology and is designed to be used with TI's Equibit™ modulators. This system requires only a simple passive demodulation filter to deliver high-quality, high-efficiency audio amplification.

TAS5086DBT is a high-performance, 32-bit (24-bit input) multichannel PurePath Digital™ pulse width modulator (PWM) based on Equibit™ technology with new, fully symmetrical AD modulation scheme.

This EVM is configured with four single-ended (SE) channels, two bridge-tied load (BTL) channels for the center, and subwoofer channels.

This EVM, together with a TI input-USB board 2, is a complete 5-channel plus subwoofer line output digital audio amplifier system which includes digital input (S/PDIF), analog inputs, interface to PC and DAP features like digital volume control, input and output mixers, automute, tone controls, loudness, EQ filters, and dynamic range compression (DRC). Configuration options are available for power stage failure protection.

Table 1. TAS5342LDDV6EVM Specification

Key Parameters	
Output Stage Supply Voltage:	0 V – 32 V
Number of Channels	2 x BTL, 4 x SE
Load Impedance BTL:	4–8 Ω
Load Impedance SE:	3–4 Ω
Output power BTL	112 W / 4 Ω 10% THD or 67 W / 8 Ω / 10% THD
Output power SE	41 W / 3 Ω / 10% THD
DNR	>109 dB
PWM Processor	TAS5086DBT
Output Stage	TAS5342LDDV

Overview

This 6-channel system designed for home theater applications such as A/V receivers, DVD receivers, DVD minicomponent systems, or home theater in a box (HTIB).

This document covers EVM specifications, audio performance and power efficiency measurements graphs, and design documentation that includes schematics, parts list, layout, and mechanical design.

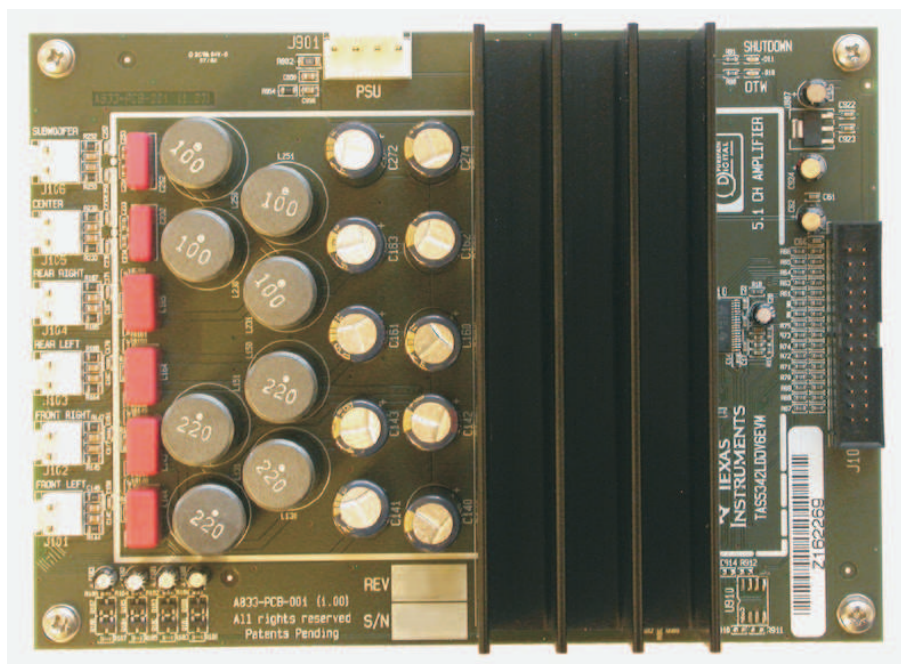

Gerber (layout) files are available at www.ti.com.

The EVM is delivered with cables and Input-USB board 2 to connect to an input source and be controlled from a personal computer (PC).

1.1 TAS5342LDDV6EVM Features

- 6-channel PurePath Digital™ evaluation module.
- Self-contained protection system (short circuit and thermal).
- Standard I²S™ and I²C™/control connector for TI input board
- Double-sided plated-through PCB layout.

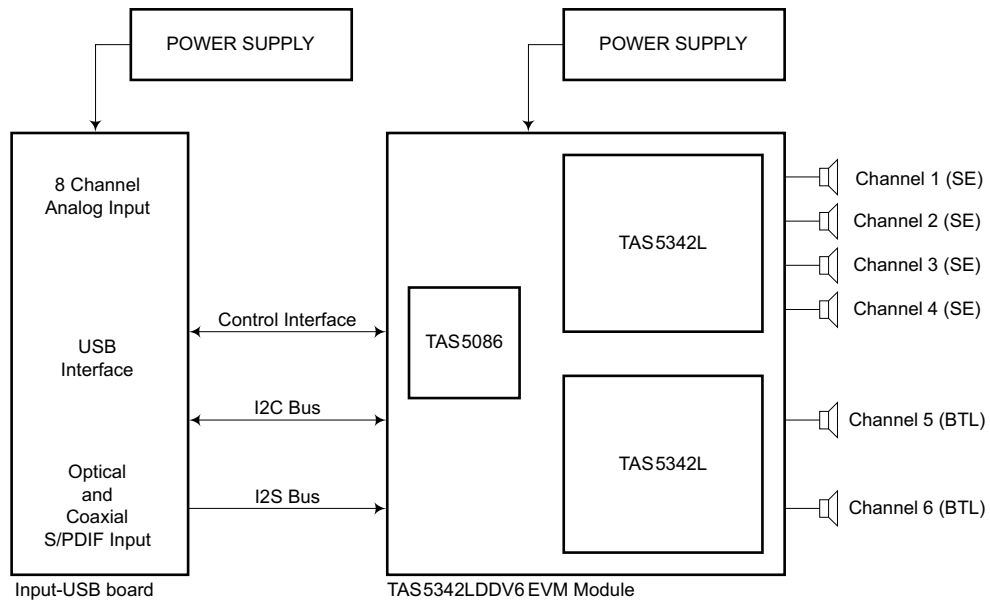

Figure 1. Integrated PurePath Digital™ Amplifier System

1.2 PCB Key Map

Physical structure for the TAS5342LDDV6EVM is illustrated in [Figure 2](#).

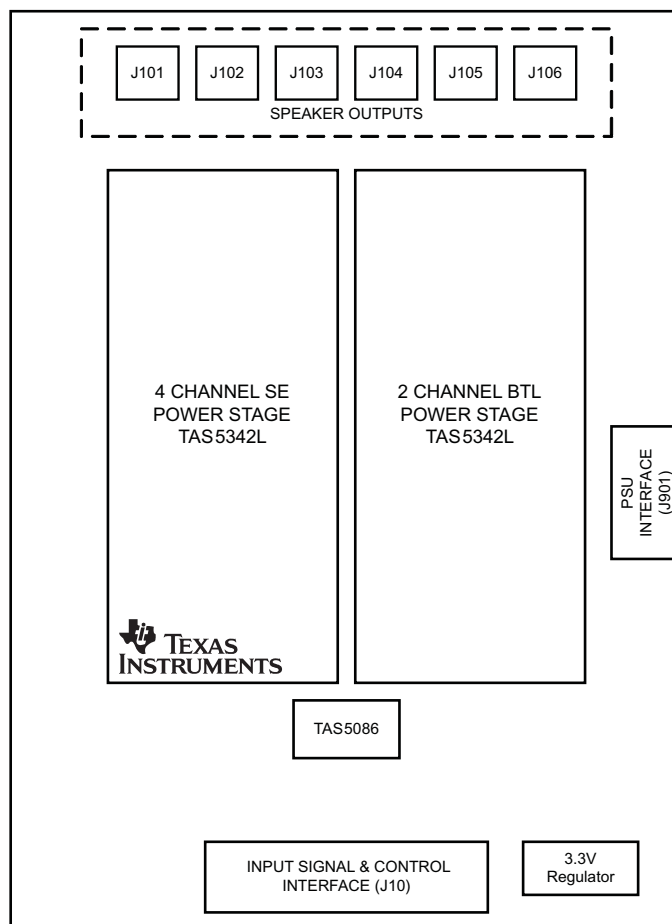

Figure 2. Physical Structure for the TAS5342LDDV6EVM (Approximate Layout)

2 Quick Setup Guide

This section describes the TAS5342LDDV6EVM board in regards to power supplies and system interfaces. The section provides information regarding handling and unpacking, absolute operating conditions, and a description of the factory default switch and jumper configuration.

Also provided is a step-by-step guide to configuring the TAS5342LDDV6EVM for device evaluation.

2.1 Electrostatic Discharge Warning

Many of the components on the TAS5342LDDV6EVM are susceptible to damage by electrostatic discharge (ESD). Customers are advised to observe proper ESD handling precautions when unpacking and handling the EVM, including the use of a grounded wrist strap at an approved ESD workstation.

CAUTION

Failure to observe ESD handling procedures may result in damage to EVM components.

2.2 Unpacking the EVM

On opening the TAS5342LDDV6EVM package, ensure that the following items are included:

- 1 pc. TAS5342LDDV6EVM board using one TAS5086DBT and two TAS5342LDDV.
- 1 pc. TI Input-USB 2 board for interfacing TAS5342LDDV6EVM with SPDIF/analog sources and PC for control.
- 1 pc. Signal and Control Interface IDC cable for connection to an I²S front-end like the attached TI Input-USB board 2.
- 1 pc. Cable for connecting Input-USB board 2 to a USB port on a PC for TAS5086 control by software.
- 1 pc. Power supply cable for a regulated power supply (H-bridge supply).
- 1 pc. AC-to-DC external 15-V power supply (system supply).
- 4 pc. AC input clips for external 15-V power supply (US, Europe, UK, and Australia).
- 1 pc. PurePath CD-ROM.

If any of these items are missing, contact the Texas Instruments Product Information Center nearest you to inquire about a replacement.

Connect the Input-USB board to the TAS5342LDDV6EVM using the delivered IDC cable.

2.3 Power Supply Setup

To power up the EVM, two power supplies are needed. One for system power, logic and gate-drive, and one for output stage supply. The H-bridge power supply is connected to the EVM using the delivered white/black power cable. The system power supply is supplied from the enclosed external 15-V wall plug adapter.

Table 2. Recommended Supply Voltages

Description	Voltage Limitations	Current Requirement	Cable
Output stage power supply	0 – 32 V	10 A	White/Black

CAUTION

Applying voltages above the limitations given in [Table 2](#) may cause permanent damage to your hardware

Note: The length of power supply cable must be minimized. Increasing length of PSU cable is equal to increasing the distortion for the amplifier at high output levels and low frequencies.

2.4 Speaker Connection

CAUTION

Both positive and negative speaker outputs are floating and may not be connected to ground (e.g., through an oscilloscope)

2.5 GUI Software Installation

The TAS5086 graphical user interface (GUI) provides easy control of all registers in TAS5086. To install the GUI, run the setup file from the PurePath CD-ROM.

After installation, turn on the power supplies, and connect the USB cable to the Input-USB board.

Start the GUI program from the Windows™ menu. The start-up of the GUI takes a few seconds.

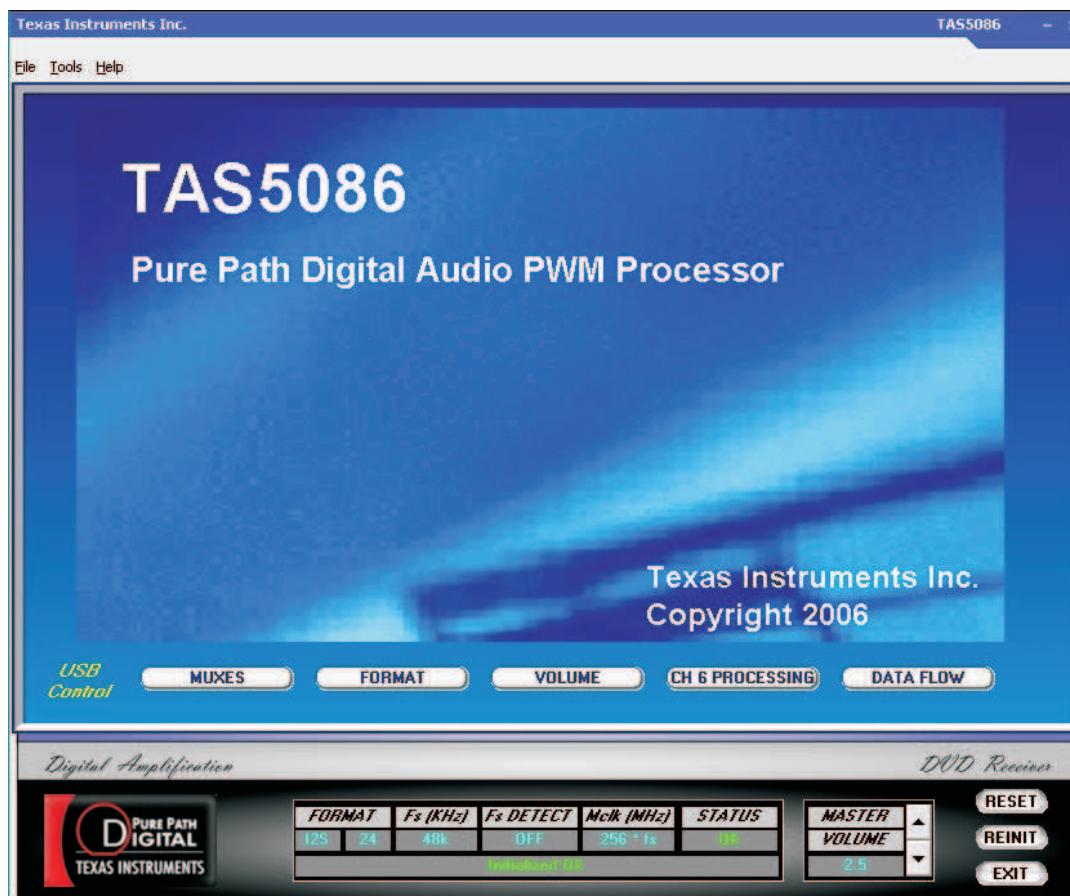

Figure 3. TAS5086 GUI Window

From the files menu, load the configuration file:

TAS5342LDDV6EVM Configuration (2.00).cfg

The file is located on the PurePath CD-ROM. This file contains all settings for a default setup of the EVM.

For easy access of the file, copy the files into the directory where the GUI is installed. Default is C:\Program Files\Texas Instruments Inc\TAS5086\

For more advanced use of the GUI, see the GUI User's Guide and data manual for the TAS5086 device.

3 Protection

This section describes the short-circuit protection and fault reporting circuitry of the TAS5342L device.

3.1 Short-Circuit Protection and Fault-Reporting Circuitry

The TAS5342L is a self-protecting device that provides fault reporting (including high-temperature protection and short-circuit protection). TAS5342L is configured in back-end auto-recovery mode and therefore resets automatically after all errors (M1, M2, and M3 is set low); see the data sheet for further explanation. This means that the device restarts itself after an error occasion and reports shortly thereafter through the \overline{SD} error signal.

3.2 Fault Reporting

The \overline{OTW} and \overline{SD} outputs from TAS5342L indicate fault conditions. See the TAS5342L data sheet ([SLAS558](#)) for a description of these pins.

Table 3. TAS5342L Warning/Error Signal Decoding

OTW	SD	Device Condition
0	0	High-temperature error and/or high current error
0	1	High-temperature warning
1	0	Undervoltage lockout or high-current error
1	1	Normal operation, no errors/warnings

The temperature warning signals at the TAS5342LDDV6EVM board are wired-OR to one temperature warning signal (\overline{OTW} – pin 22 in control interface connector).

Shutdown signals are wired-OR into one shutdown signal (\overline{SD} – pin 20 in control interface connector).

The shutdown signals together with the temperature warning signal give chip state information as described in Table 3. Device fault-reporting outputs are open-drain outputs.

4 TAS5342LDDV6EVM Performance

Table 4. General Test Conditions

General Test Conditions	Notes
Output stage supply voltage:	32 V Laboratory power supply (EA-PS 7065-10A)
Load impedance SE:	3-4 Ω
Load impedance BTL:	4-8 Ω
Input signal	1 kHz Sine
Sampling frequency	48 kHz
Gain setting in TAS5086	0 dB
Measurement filter	AES17 and AUX0025
TI Input Board	Input-USB board 2 Rev 1
EVM configuration file	Ver 2.00 TAS5342LDDV6EVM Configuration (2.00).cfg

Note: These test conditions are used for all tests, unless otherwise specified.

Table 5. TAS5086 Register Settings

Register	Register	Value	Notes
Oscillator Trim Register	0x1B	0x00	Initiate factory trim
Master Volume Register	0x07	0x30	Master volume set to -15 dB
Split Cap Register	0x1A	0x00	No split capacitor charge period.
Modulation Index Limit Register	0x10	0x02	Set modulation index to 97.7 %
PWM Start Register	0x18	0xF0	Mid-Z sequence enabled for all channels.
Input Multiplexer Register	0x20	0x00 01 23 45	Input mixer register
Output Multiplexer Register	0x25	0x00 01 23 45	PWM mixer register
System Control Register	0x05	0x20	PM start

Note: These register settings are used for all test, unless otherwise specified

Table 6. Electrical Data

Electrical Data	Notes/Conditions
Output power, SE, 3 Ω :	30 W 1 kHz, unclipped (0dBFS), $T_A = 25^\circ\text{C}$
Output power, SE, 3 Ω :	41 W 1 kHz, 10% THD+N, $T_A = 25^\circ\text{C}$
Output power, SE, 4 Ω :	24 W 1 kHz, unclipped (0 dBFS), $T_A = 25^\circ\text{C}$
Output power, SE, 4 Ω :	33 W 1 kHz, 10% THD+N, $T_A = 25^\circ\text{C}$
Output power, BTL, 4 Ω :	88 W 1 kHz, unclipped (0 dBFS), $T_A = 25^\circ\text{C}$
Output power, BTL, 4 Ω :	112 W 1 kHz, 10% THD+N, $T_A = 25^\circ\text{C}$
Output power, BTL, 8 Ω :	51 W 1 kHz, unclipped (0 dBFS), $T_A = 25^\circ\text{C}$
Output power, BTL, 8 Ω :	67 W 1 kHz, 10% THD+N, $T_A = 25^\circ\text{C}$

Table 6. Electrical Data (continued)

Electrical Data		Notes/Conditions
Maximum peak current, SE:	>9.5 A	1-kHz burst, 1 Ω , ROC = 27 k Ω
Maximum peak current, BTL:	>9.8 A	1-kHz burst, 1 Ω , ROC = 27 k Ω
Output stage efficiency:	90 %	2 x channels, 4 Ω
Damping factor SE:	12	1 kHz, relative to 4- Ω load
Damping factor BTL:	12.5	1 kHz, relative to 8- Ω load
H-Bridge supply current:	<156 mA	1 kHz, -60-dBFS signal
Idle power consumption:	5 W	H-bridge supply, -60-dBFS input signal

Table 7. Audio Performance

Audio Performance		Notes/Conditions
THD+N, SE, 3 Ω :	1 W	<0.049% 1 kHz
THD+N, SE, 3 Ω :	10 W	<0.058% 1 kHz
THD+N, SE, 3 Ω :	30 W	<0.2% 1 kHz
THD+N, SE, 4 Ω :	1 W	<0.03% 1 kHz
THD+N, SE, 4 Ω :	10 W	<0.047% 1 kHz
THD+N, SE, 4 Ω :	20 W	<0.055% 1 kHz
THD+N, BTL, 4 Ω :	1 W	<0.008% 1 kHz
THD+N, BTL, 4 Ω :	10 W	<0.02% 1 kHz
THD+N, BTL, 4 Ω :	80 W	<0.37% 1 kHz
THD+N, BTL, 8 Ω :	1 W	<0.0048% 1 kHz
THD+N, BTL, 8 Ω :	10 W	<0.026% 1 kHz
THD+N, BTL, 8 Ω :	50 W	<0.09% 1 kHz
Dynamic range:	>110 dB	Ref: rated power, A-weighted, AES17 filter, 4 ch avg
Noise voltage:	<35 μ Vrms	A-weighted, AES17 filter
Channel separation:	>67 dB	1 kHz
Frequency response SE:	0.1 / -0.7 dB	25 W/4 Ω , unclipped (0 dBFS)
Frequency response BTL:	0.0 / -0.7 dB	52 W / 8 Ω , unclipped (0 dBFS)

Table 8. Thermal Specification

Thermal specification**	THEATSINK*	Notes/Conditions
Idle, all channels switching	31°C	1 kHz, 15 min, -60-dBFS signal, T _A = 25°C
4x3.4 W, 3 Ω + 2x10 W, 4 Ω (1/8 power)	42°C	1 kHz, 1 hour, T _A = 25°C
2x32 W, 3 Ω	44°C	1 kHz, 5 min, T _A = 25°C

*Measured on surface of heatsink.

Table 9. Physical Specifications

Physical Specifications		Notes/Conditions
PCB dimensions:	112 x 154 x 54	Width x length x height (mm)
Total weight:	320 gr.	Components + PCB + heatsink + mechanics

Note: All electrical and audio specifications are typical values.

4.1 THD+N vs Power (SE -3 Ω)

Gain: +2.5 dB set in TAS5086

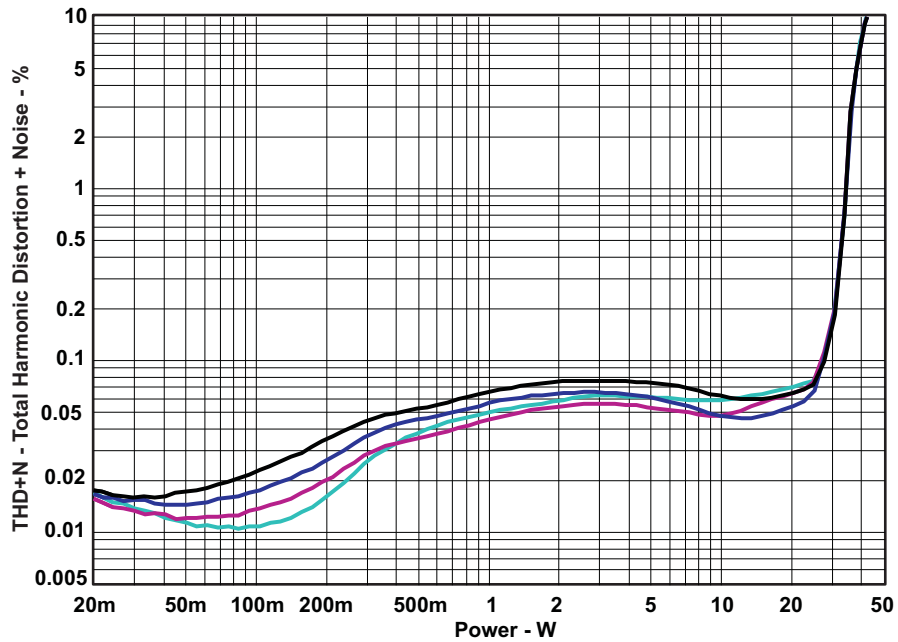

Figure 4. THD+N vs Power (SE -3 Ω)

4.2 THD+N vs Power (SE -4 Ω)

Gain: +2.5 dB set in TAS5086

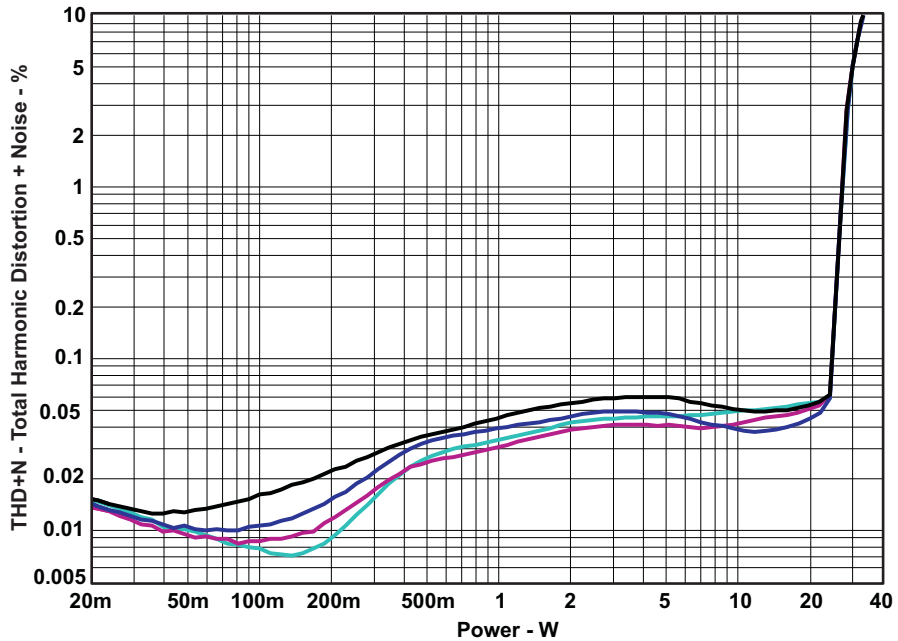

Figure 5. THD+N vs Power (SE -4 Ω)

4.3 THD+N vs Power (BTL -4 Ω)

Gain: +2.5 dB set in TAS5086

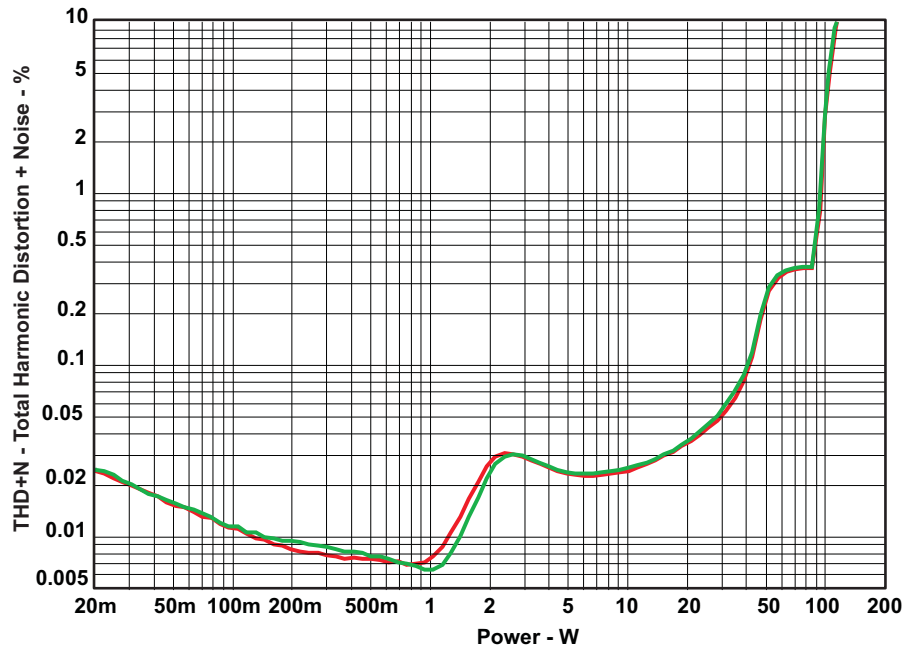

Figure 6. THD+N vs Power (BTL -4 Ω)

4.4 THD+N vs Power (BTL -8 Ω)

Gain: +2.5 dB set in TAS5086

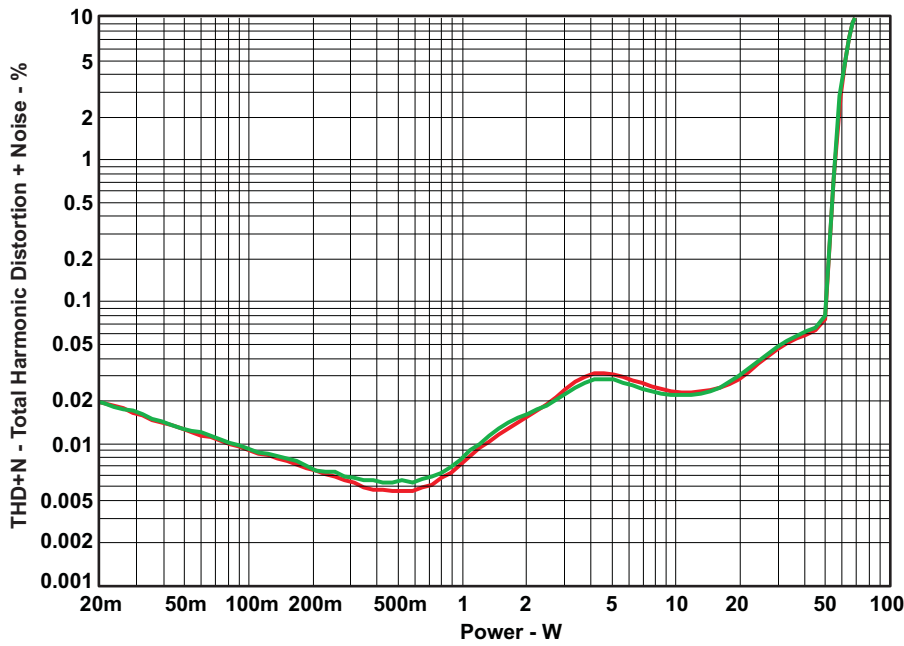

Figure 7. THD+N vs Power (BTL -8 Ω)

4.5 THD+N vs Frequency (SE -3Ω)

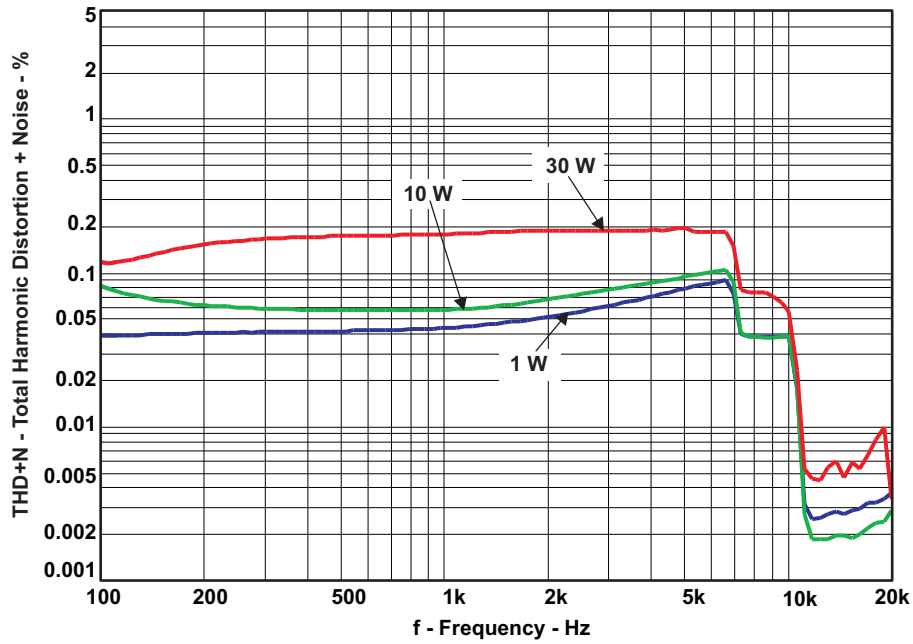

Figure 8. THD+N vs Frequency (SE -3Ω)

4.6 THD+N vs Frequency (SE -4Ω)

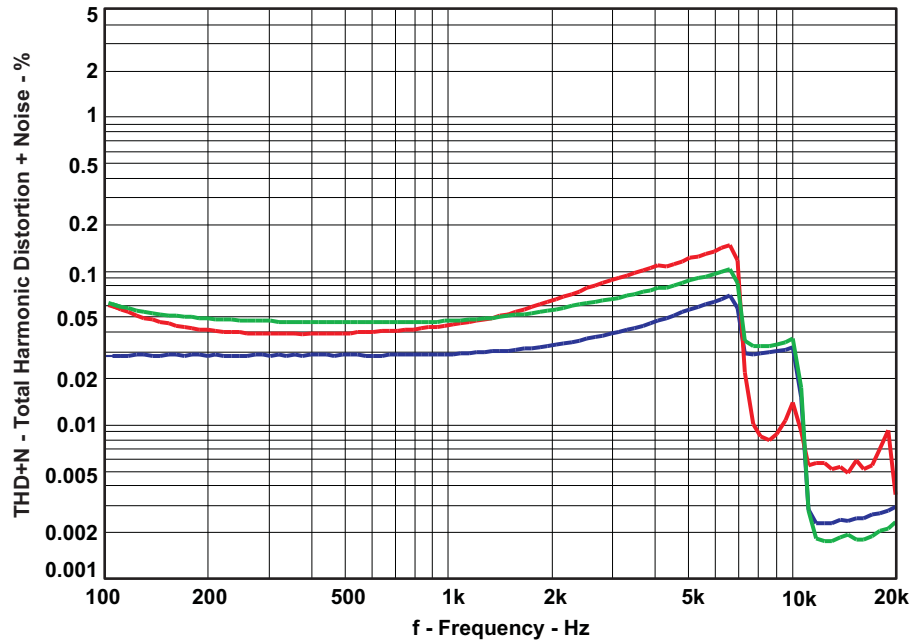

Figure 9. THD+N vs Frequency (SE -4Ω)

4.7 THD+N vs Frequency (BTL -4 Ω)

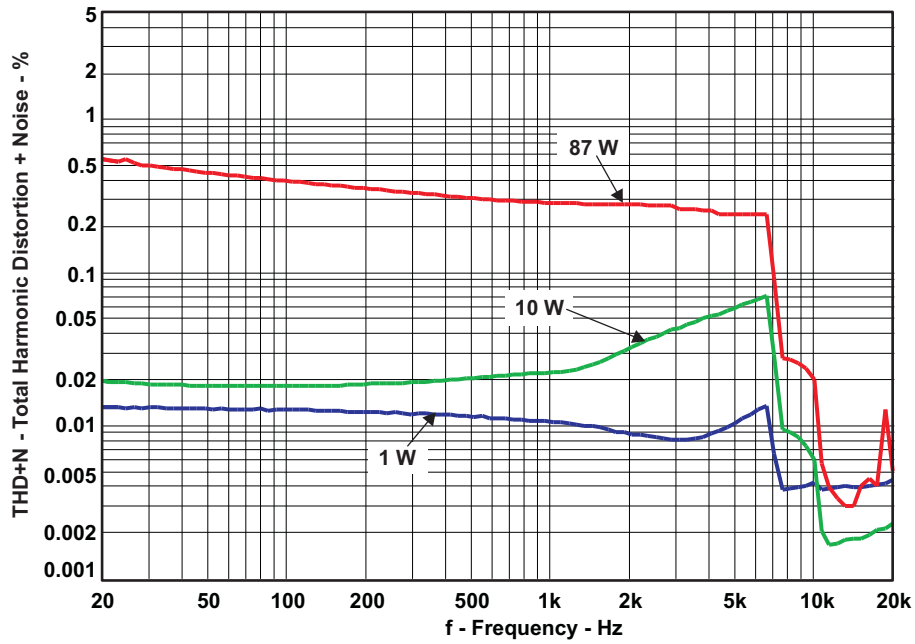

Figure 10. THD+N vs Frequency (BTL -4 Ω)

4.8 THD+N vs Frequency (BTL -8 Ω)

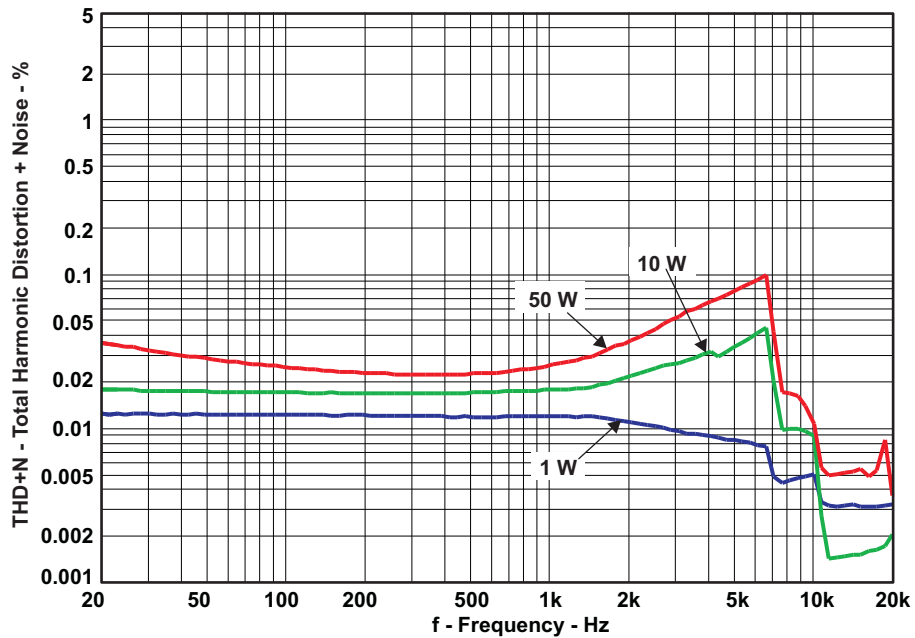

Figure 11. THD+N vs Frequency (BTL -8 Ω)

4.9 FFT Spectrum With -60-dBFS Tone (SE)

Reference voltage is 10 V. FFT size 16k.

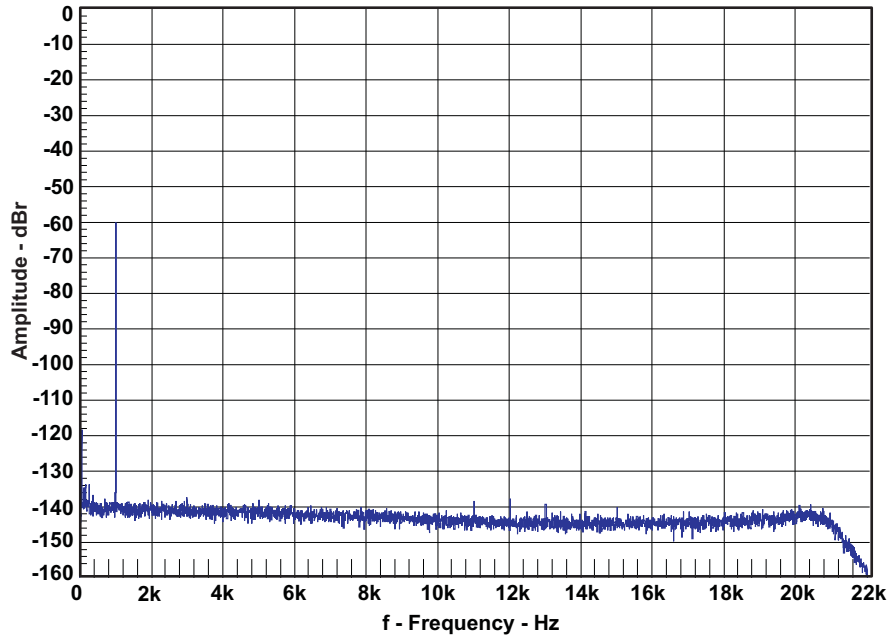

Figure 12. FFT Spectrum With -60-dBFS Tone (SE)

4.10 FFT Spectrum With -60-dBFS Tone (BTL)

Reference voltage is 20.4 V. FFT size 16k.

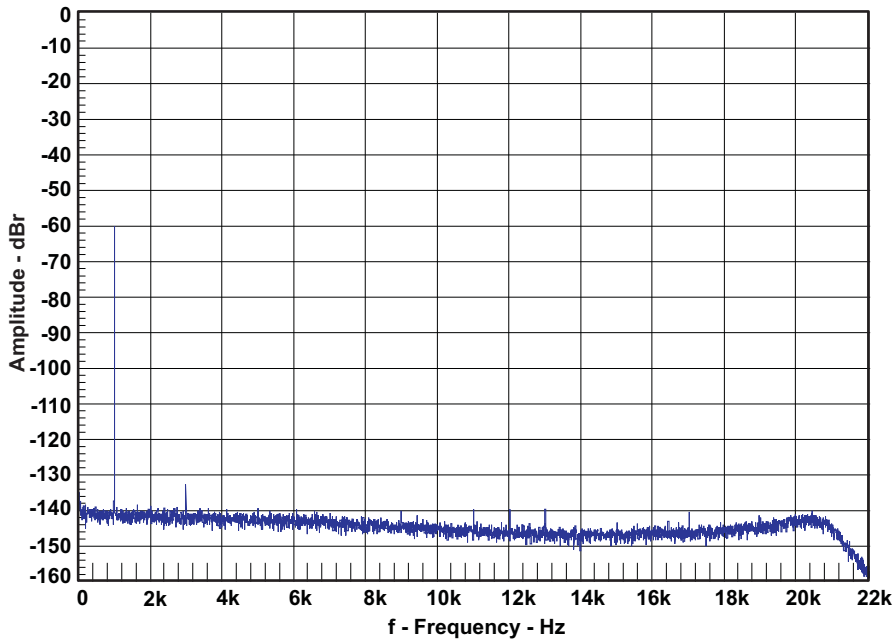

Figure 13. FFT Spectrum With -60-dBFS Tone (BTL)

4.11 Idle Noise FFT Spectrum (SE)

Reference voltage is 10 V. FFT size 16k.

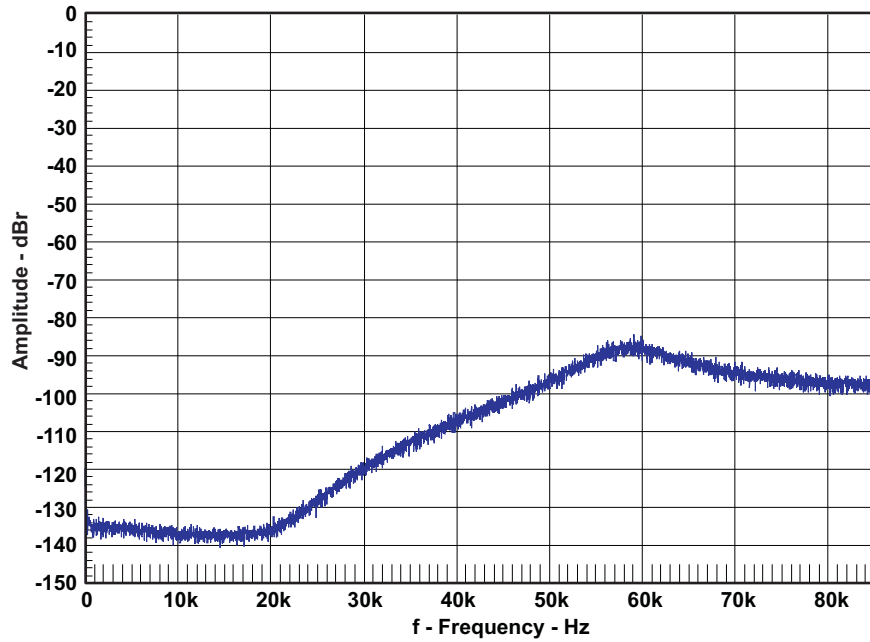

Figure 14. Idle Noise FFT Spectrum (SE)

4.12 Idle Noise FFT Spectrum (BTL)

Reference voltage is 20.3 V. FFT size 16k.

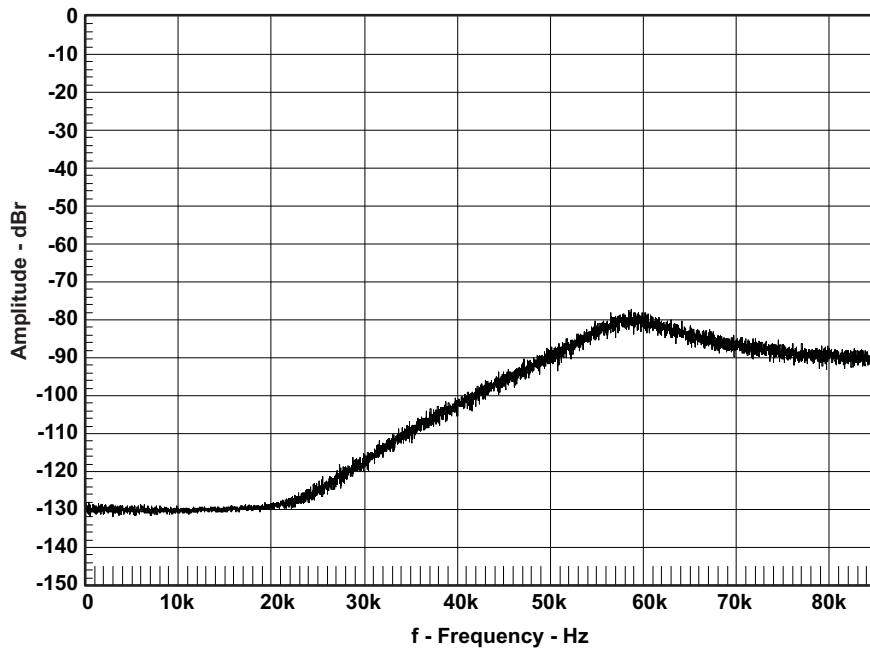

Figure 15. Idle Noise FFT Spectrum (BTL)

4.13 Channel Separation

Channel separation is tested for two channels in different package, channel 1 and channel 2. Four-ohm loads are used for both channels. Channel 1 input signal is 0 dBFS; channel 2 is muted. Reference voltage 10 Vrms.

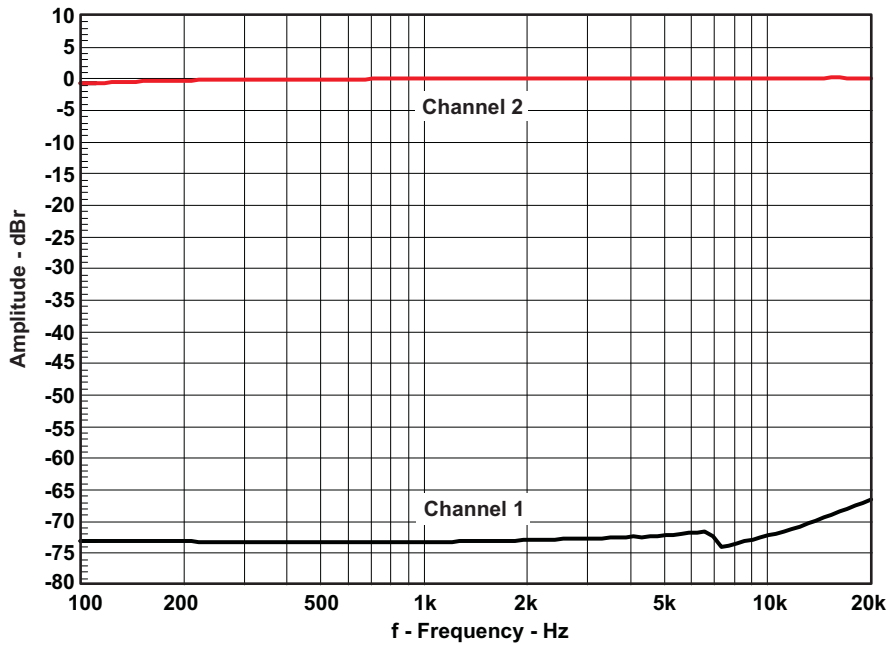

Figure 16. Channel Separation

4.14 Frequency Response (SE)

Measurement bandwidth filter 80 kHz.

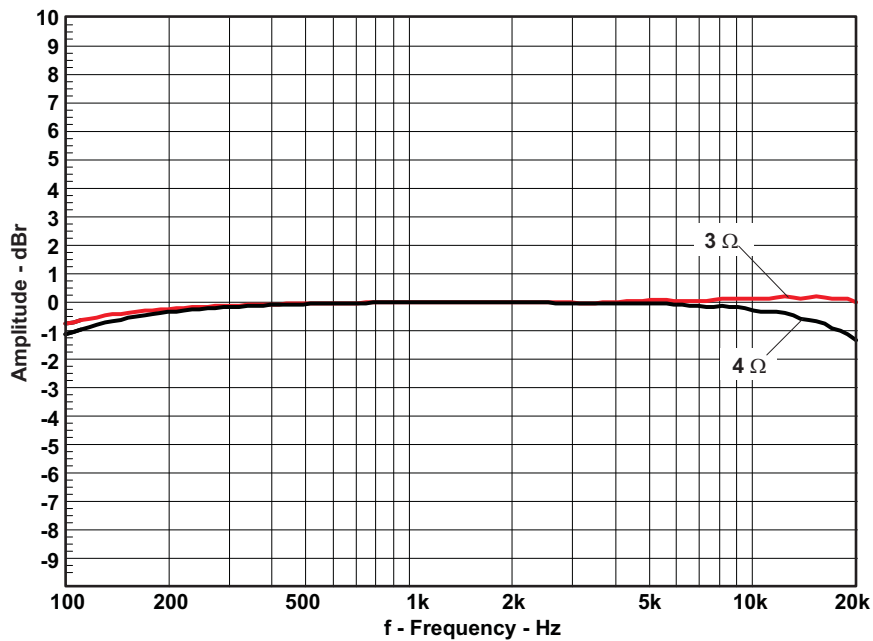

Figure 17. Frequency Response (SE)

4.15 Frequency Response (BTL)

Measurement bandwidth filter 80 kHz.

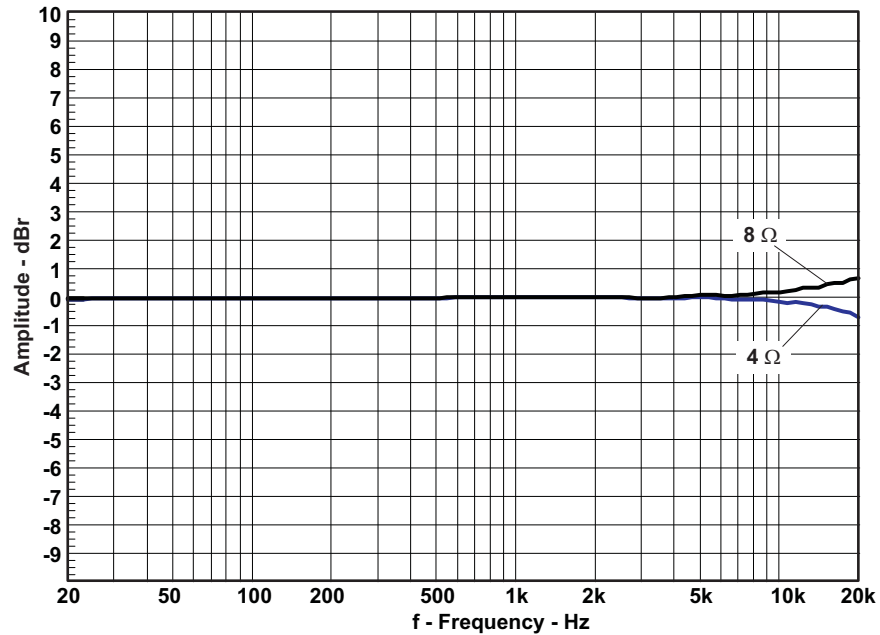

Figure 18. Frequency Response (BTL)

4.16 High-Current Protection (SE)

Input 1kHz bursted signal; load is 1 Ω.

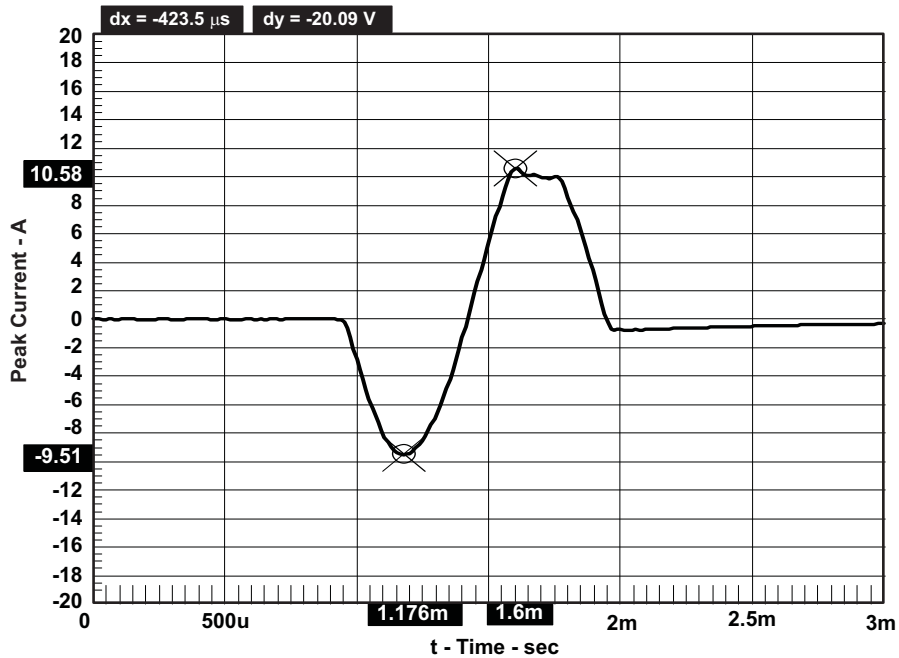

Figure 19. High-Current Protection (SE)

4.17 High Current Protection (BTL)

Input 1kHz bursted signal; load is 1 Ω .

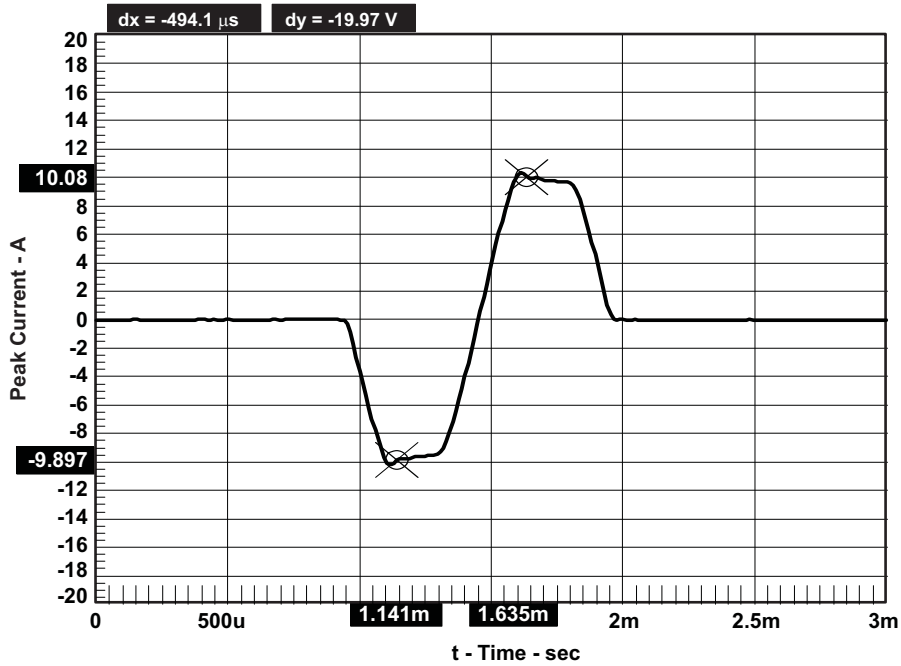

Figure 20. High-Current Protection (BTL)

4.18 Pop/Click (SE)

No input signal is applied. The measurement results are presented in frequency domain.

No input signal is applied. Load is 8 Ω .

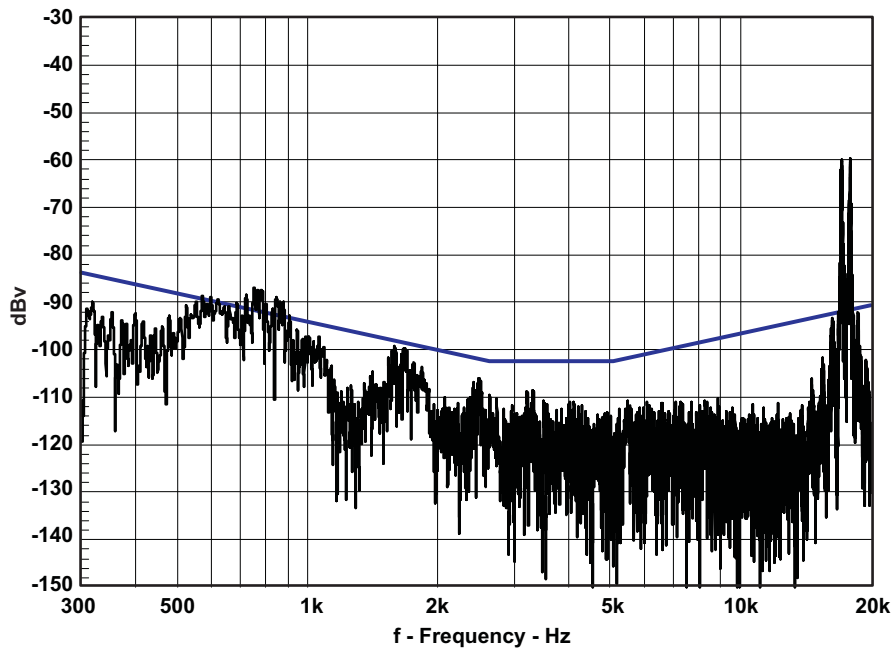

Figure 21. Pop/Click (SE)

4.19 Pop/Click (BTL)

No input signal is applied. The measurement results are presented in frequency domain.

No input is signal applied. Load is 4 Ω .

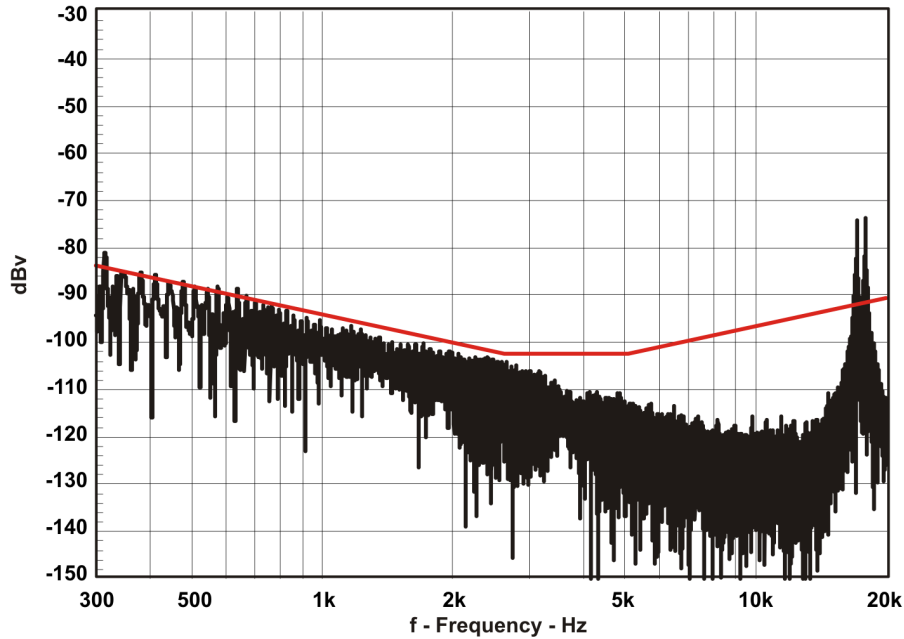

Figure 22. Pop/Click (BTL)

4.20 Output Stage Efficiency

Efficiency is tested with two channels loaded with 4 Ω . The board has been preheated for 1 hour at 1/8 output power.

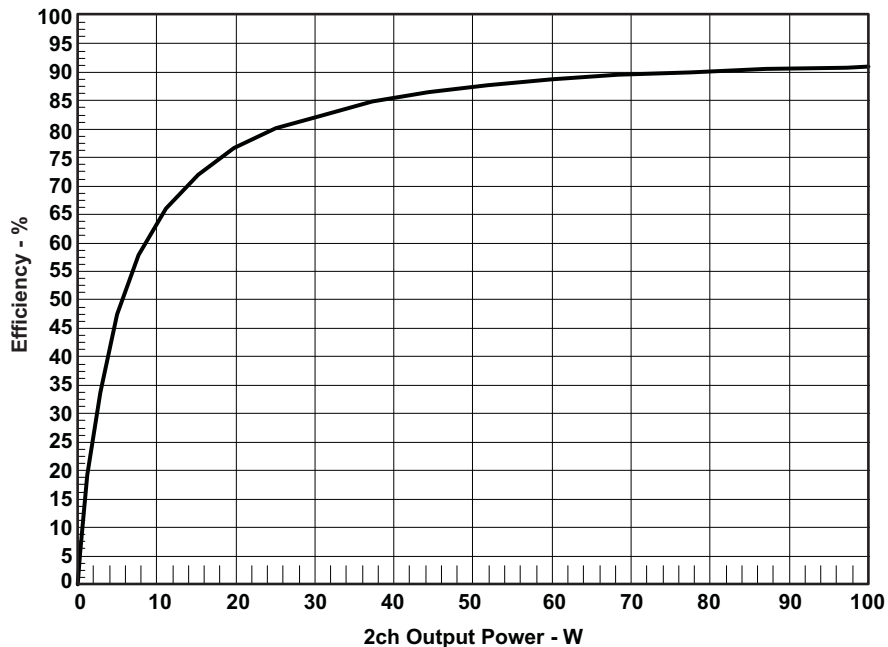

Figure 23. Output Stage Efficiency

5 Related Documentation from Texas Instruments

Table 10 contains a list of data sheets that have detailed descriptions of the integrated circuits used in the design of the TAS5342LDDV6EVM. The data sheets can be obtained at the URL <http://www.ti.com>.

Table 10. Related Documentation From Texas Instruments

Part Number	Literature Number
TAS5086	SLES131
TAS5342L	SLAS558
TPS3801K33	SLVS219
TLV1117-33C	SLVS561

5.1 Additional Documentation

1. *PC Configuration Tool for TAS5086* application report (TAS5086 GUI ver. 4.0 or later)
2. *System Design Considerations for True Digital Audio Power Amplifiers* application report (([SLAA117](#)))
3. *Digital Audio Measurements* application report (([SLAA114](#)))
4. *PSRR for PurePath Digital Audio Amplifiers* application report (([SLEA049](#)))
5. *Power Rating in Audio Amplifier* application report (([SLEA047](#)))
6. *PurePath Digital AM Interference Avoidance* application report (([SLEA040](#)))
7. *Click and Pop Measurements Technique* application report (([SLEA044](#)))
8. *Power Supply Recommendations for DVD-Receivers* application report (([SLEA027](#)))
9. *Implementation of Power Supply Volume Control* application report (([SLEA038](#)))

Appendix A Design Documents

A.1 TAS5342LDDV6EVM Schematic

Version 2.00 (6 pages)

A.2 TAS5342LDDV6EVM Parts List

Version 2.00 (2 pages)

A.3 TAS5342LDDV6EVM PCB Specification

Version 1.00 (1 page)

A.4 TAS5342LDDV6EVM PCB Layers

Version 1.00 (5 pages)

A.5 Heatsink Drawing

Version 1.00 (1 Page)



Design Name: **TAS5342LDDV6EVM**
 Type: Mass Market Evaluation Module
 File Name: A833-SCH-001.DSN
 Version: 2.00
 Date: 29.February 2008
 Design Engineer: Jonas L. Holm (jlh@ti.com)
 Audio Configuration: 5.1 PurePath Digital Amplifier Design
 1 x TAS5086, 2 x TAS5342LDDV

Interfaces: J10: 26 pin IDC Header for I2S Audio, Control, I2C, +5V and +12V
 J101-J106: 2 pin 3.96mm Headers for Speakers
 J901: 4 pin 3.96mm Header for H-Bridge and System Power Supply

Setup: 4 x 3 Ohm and 2 x 4 Ohm Speaker Loads
 +32V H-Bridge Supply Voltage

Performance: 4 x 30 W/3 Ohm (SE) + 2 x 80 W/4 Ohm (BTL) - all unclipped.
 105 dB Dynamic Range

Page

- 1/6: Front Page and Schematic Disclaimer
- 2/6: Overview - Modulator and Input/Output
- 3/6: 4 Channel SE Power Stage (FL, FR, SL, and SR)
- 4/6: 2 Channel BTL Power Stage (C and LFE SW)
- 5/6: Power Supplies
- 6/6: Mechanics

Copyright 2008 Texas Instruments, Inc - All rights reserved - The "TI" and "PurePath Digital" logos are trademarks of Texas Instruments.

NOTE1

SCHEMATIC DISCLAIMER

The schematic information and materials ("Materials") provided here are provided by Texas Instruments Incorporated ("TI") as a service to its customers and/or suppliers, and may be used for informational purposes only, and only subject to the following terms. By downloading or viewing these Materials, you are signifying your assent to these terms.

- 1.) These evaluation schematics are intended for use for **ENGINEERING DEVELOPMENT AND EVALUATION PURPOSES ONLY** and are not considered by Texas Instruments to be fit as a basis for establishing production products or systems. This information may be incomplete in several respects, including but not limited to information relating to required design, marketing, and/or manufacturing-related protective considerations and product safety measures typically found in the end-product incorporating the goods.
- 2.) Accordingly, neither TI nor its suppliers warrant the accuracy or completeness of the information, text, graphics, links or other items contained within the Materials. TI may make changes to the Materials, or to the products described therein, at any time without notice. TI makes no commitment to update the Materials.
- 3.) TI assumes no liability for applications assistance, customer product design, software performance, or services that may be described or referenced in the Materials. The user assumes all responsibility and liability for proper and safe design and handling of goods. Accordingly, the user indemnifies TI from all claims arising from its use of the Materials.
- 4.) TI currently deals with various customers for products, and therefore our arrangement with the user will not be exclusive. TI makes no representations regarding the commercial availability of non-TI components that may be referenced in the Materials.
- 5.) No license is granted under any patent right or other intellectual property right of TI covering or relating to any combination, machine, or process in which such TI products or services might be or are used. Except as expressly provided herein, TI and its suppliers do not grant any express or implied right to you under any patents, copyrights, trademarks, or trade secret information.
- 6.) Performance tests and ratings, to the extent referenced in the Materials, are measured using specific computer systems and/or components and reflect the approximate performance of TI products as measured by those tests. Any difference in system hardware or software design or configuration may affect actual performance. Buyers should consult other sources of information to evaluate the performance of systems or components they are considering purchasing.
- 7.) Resale of TI's products or services with statements different from or beyond the parameters stated by TI for that product or service in official TI data books or data sheets voids all express and any implied warranties for the associated TI product or service, and is an unfair and deceptive business practice, and TI is not responsible for any such use.
- 8.) The Materials are copyrighted and any unauthorized use may violate copyright, trademark, and other laws. You may only download one copy for your internal use only, unless you are specifically licensed to do otherwise by TI in writing. This is a license, not a transfer of title, and is subject to the following restrictions: You may not: (a) modify the Materials (including any associated warranties, conditions, limitations or notices) or use them for any commercial purpose, or any public display, performance, sale or rental; (b) decompile, reverse engineer, or disassemble software Materials except and only to the extent permitted by applicable law; (c) remove any copyright or other proprietary notices from the Materials; (d) transfer the Materials to another person. You agree to prevent any unauthorized copying of the Materials. TI may terminate this license at any time if you are in breach of the terms of this Agreement. Upon termination, you will immediately destroy the Materials.
- 9.) **THE MATERIALS ARE PROVIDED "AS IS" WITHOUT ANY EXPRESS OR IMPLIED WARRANTY OF ANY KIND INCLUDING WARRANTIES OF MERCHANTABILITY, NONINFRINGEMENT OF INTELLECTUAL PROPERTY, OR FITNESS FOR ANY PARTICULAR PURPOSE. IN NO EVENT SHALL TI OR ITS SUPPLIERS BE LIABLE FOR ANY DAMAGES WHATSOEVER (INCLUDING, WITHOUT LIMITATION, DAMAGES FOR LOSS OF PROFITS, BUSINESS INTERRUPTION, LOSS OF INFORMATION) ARISING OUT OF THE USE OF OR INABILITY TO USE THE MATERIALS, EVEN IF TI HAS BEEN ADVISED OF THE POSSIBILITY OF SUCH DAMAGES.**

Not Used

TAS5342LDDV6EVM

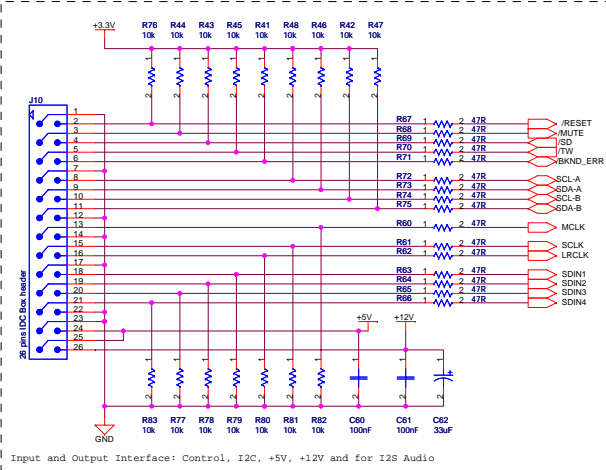

Input and Output Interface: Control, I2C, +5V, +12V and for I2S Audio

Indication of over temperature warning and shutdown.

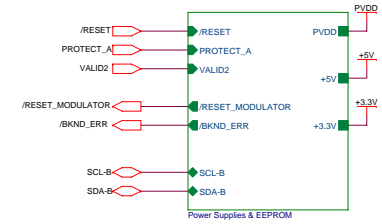
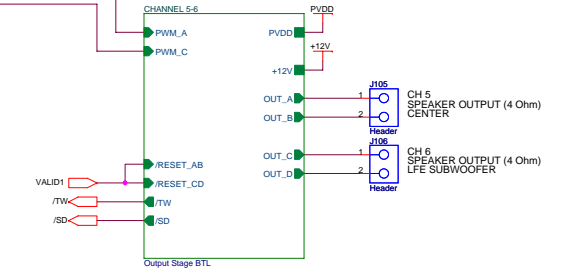
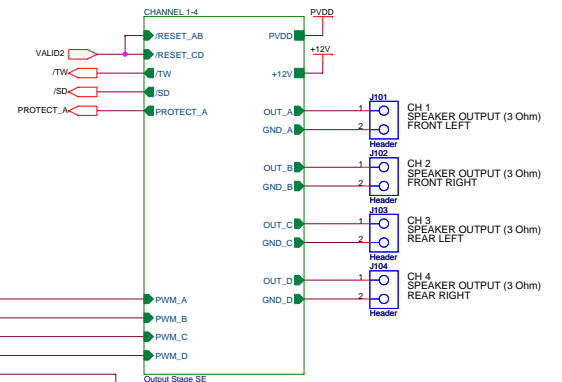
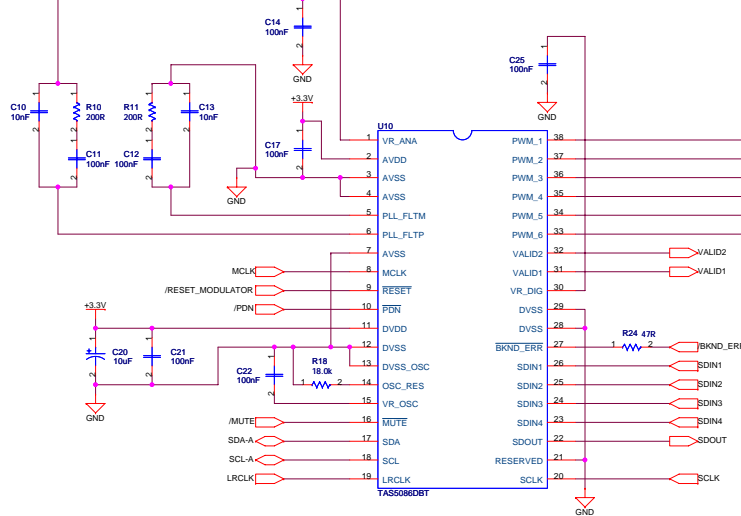
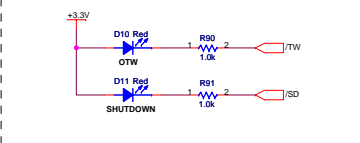

POWER OUTPUT STAGE (SE)

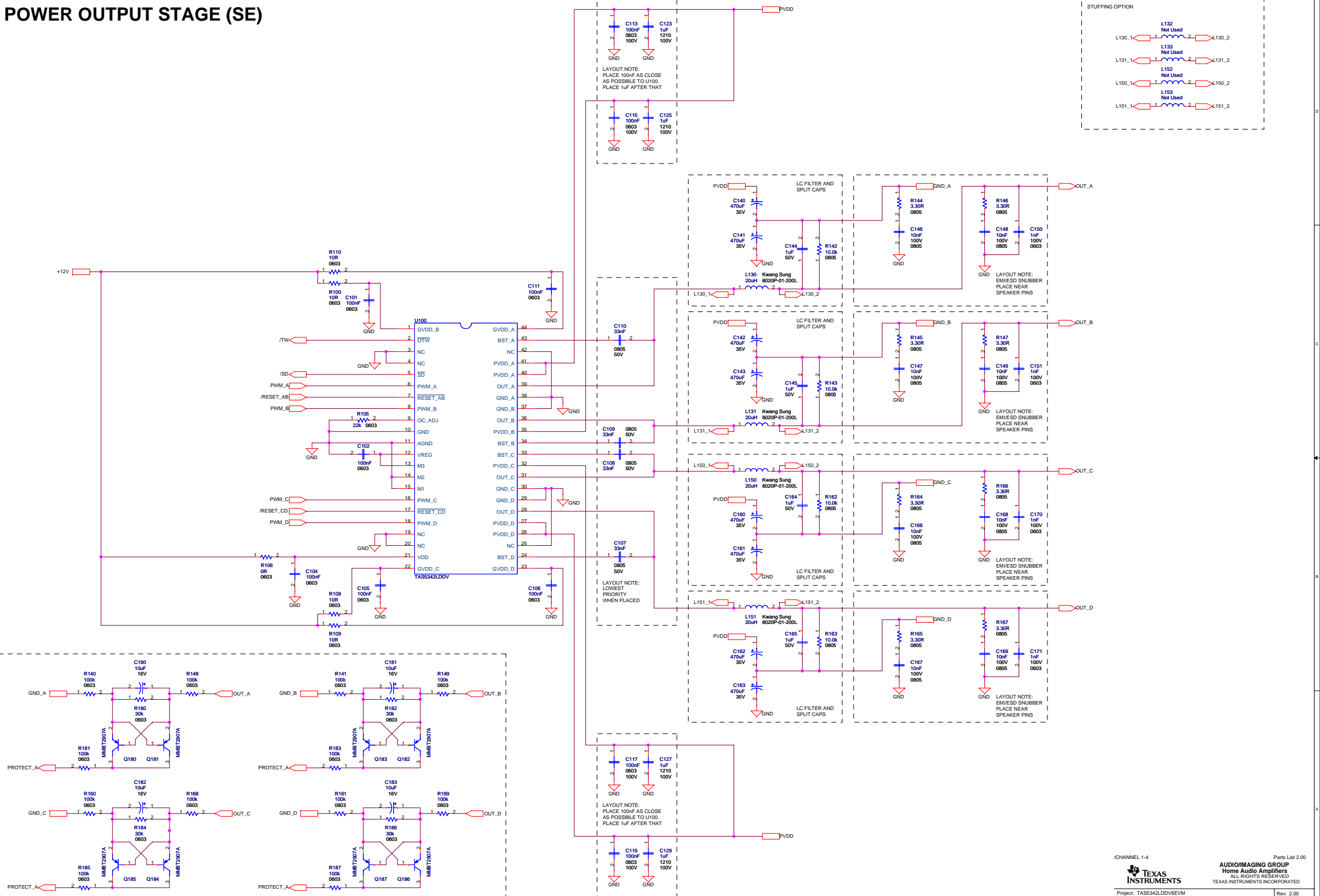

LAYOUT NOTE:
PLACE 100nF AS CLOSE
AS POSSIBLE TO U100.
PLACE 1uF AFTER THAT

LAYOUT NOTE:
LOWEST
PRIORITY
WHEN PLACED

LAYOUT NOTE:
PLACE 100nF AS CLOSE
AS POSSIBLE TO U100.
PLACE 1uF AFTER THAT

LAYOUT NOTE:
EMISS SNUBBER
PLACE NEAR
SPEAKER PINS

LAYOUT NOTE:
EMISS SNUBBER
PLACE NEAR
SPEAKER PINS

LAYOUT NOTE:
EMISS SNUBBER
PLACE NEAR
SPEAKER PINS

LAYOUT NOTE:
EMISS SNUBBER
PLACE NEAR
SPEAKER PINS

Patents pending in circuitry design and layout (WO99/59241 & WO99/59242). This circuitry may only be used together with the integrated circuit TAS562DDV from Texas Instruments Incorporated.

POWER OUTPUT STAGE (BTL)

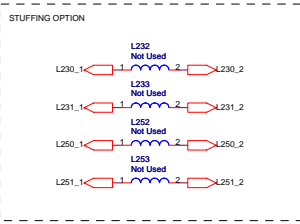
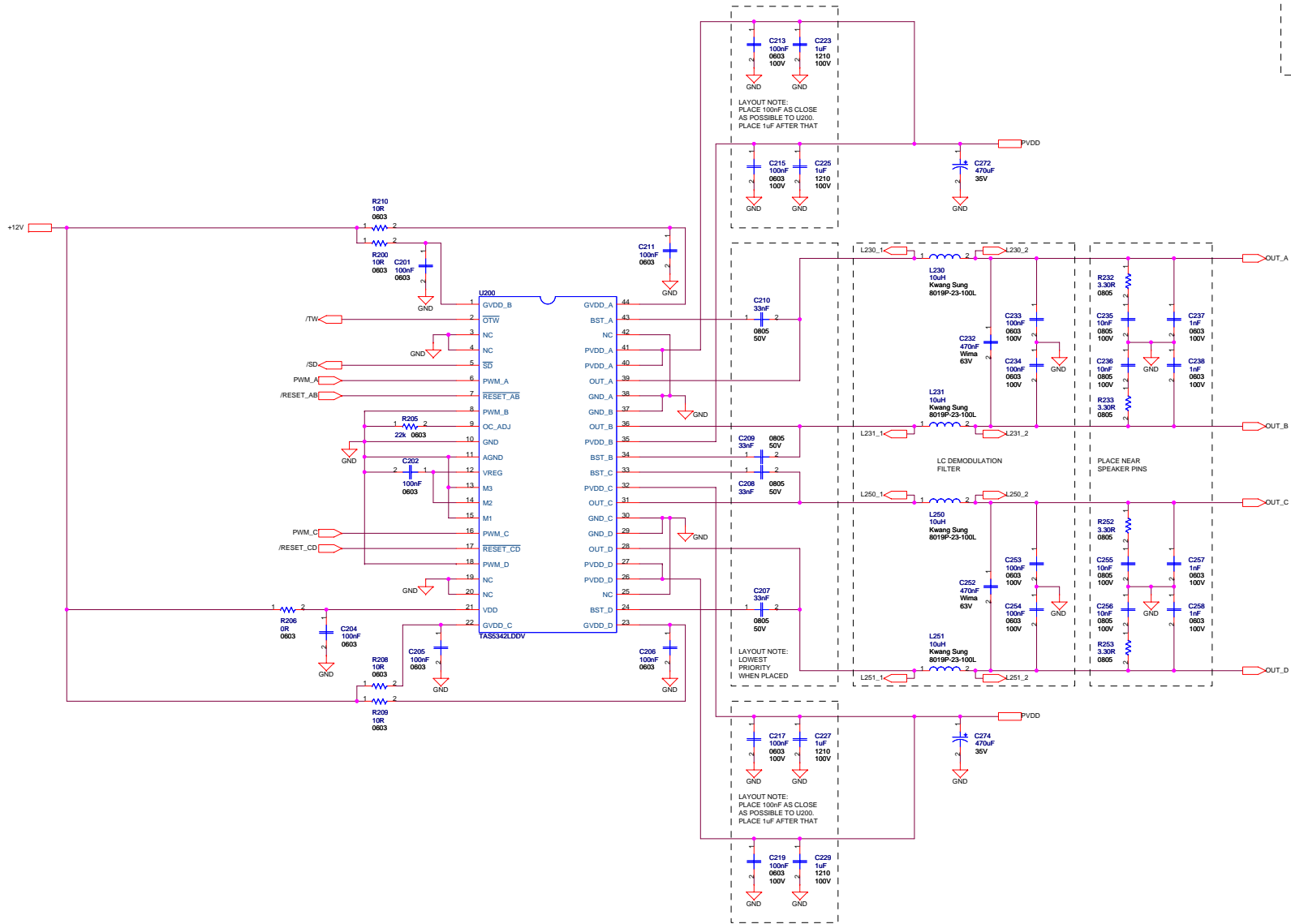

POWER SUPPLIES

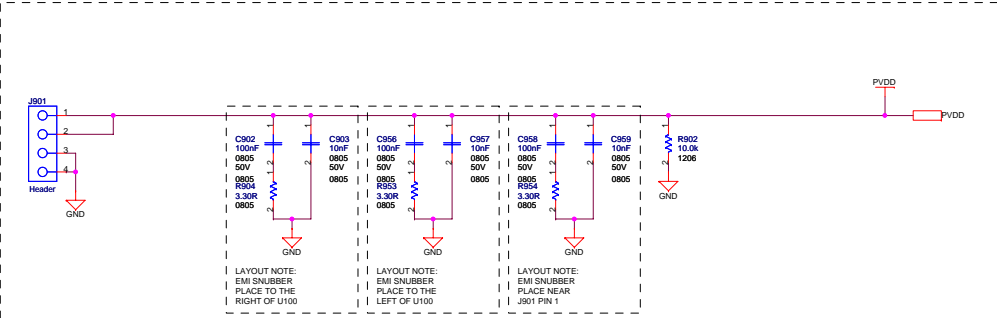

PVDD FILTER

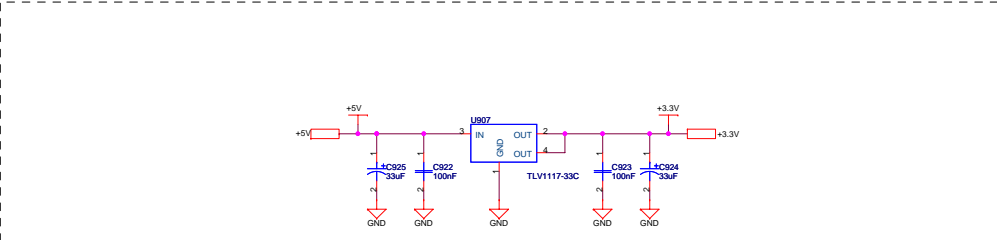

+3.3 V POWER SUPPLY

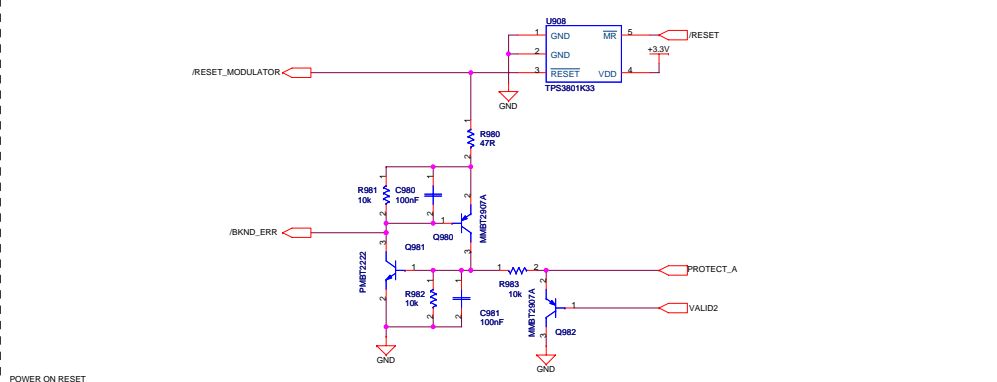

POWER ON RESET

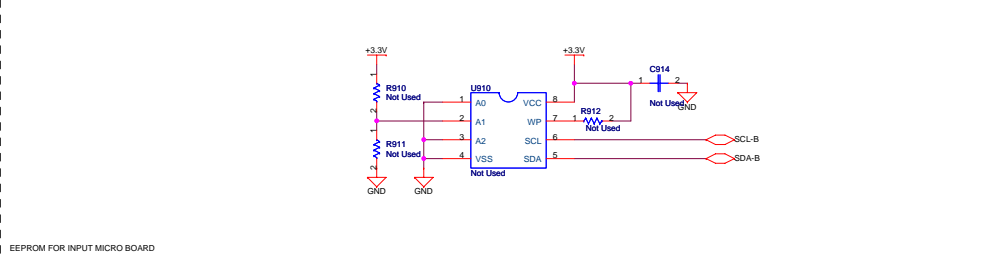

EEPROM FOR INPUT MICRO BOARD

MECHANICS

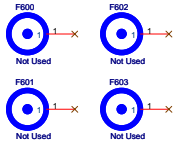
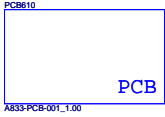
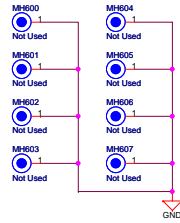
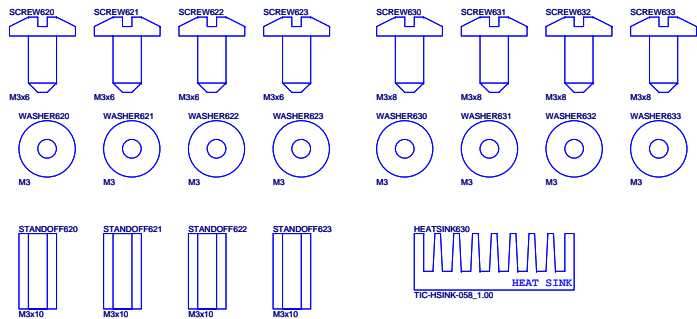

TAS5342LDDV6EVM Partslist (2.00)



Qty	Part Reference	Description	Manufacture	First Mfr P/N
1	R902	10.0k / 250mW / 1% / 1206 Thick Film Resistor	Yageo	RC1206FR-0710KL
4	R142 R143 R162 R163	10.0k / 125mW / 1% / 0805 Thick Film Resistor	Yageo	RC0805FR-0710KL
15	R144 R145 R146 R147 R164 R165 R166 R167 R232 R233 R252 R253 R904 R953 R954	3.30R / 125mW / 1% / 0805 Thick Film Resistor	Yageo	RC0805FR-073R3L
2	R106 R206	0R / 5% / 0603 Thick Film Resistor	Yageo	RC0603JR-070RL
2	R90 R91	1.0k / 100mW / 5% / 0603 Thick Film Resistor	Yageo	RC0603JR-071KL
19	R41 R42 R43 R44 R45 R46 R47 R48 R76 R77 R78 R79 R80 R81 R82 R83 R981 R982 R983	10k / 100mW / 5% / 0603 Thick Film Resistor	Yageo	RC0603JR-0710KL
12	R140 R141 R148 R149 R160 R161 R168 R169 R181 R183 R185 R187	100k / 100mW / 5% / 0603 Thick Film Resistor	Yageo	RC0603JR-07100KL
8	R100 R108 R109 R110 R200 R208 R209 R210	10R / 100mW / 5% / 0603 Thick Film Resistor	Yageo	RC0603JR-0710RL
1	R18	18.0k / 100mW / 1% / 0603 Thick Film Resistor	Yageo	RC0603JR-0718KL
2	R10 R11	200R / 100mW / 5% / 0603 Thick Film Resistor	Yageo	RC0603JR-07200RL
2	R105 R205	22k / 100mW / 5% / 0603 Thick Film Resistor	Yageo	RC0603JR-0722KL
4	R180 R182 R184 R186	30k / 100mW / 5% / 0603 Thick Film Resistor	Yageo	RC0603JR-0730KL
18	R24 R60 R61 R62 R63 R64 R65 R66 R67 R68 R69 R70 R71 R72 R73 R74 R75 R980	47R / 100mW / 5% / 0603 Thick Film Resistor	Yageo	RC0603JR-0747RL
12	C146 C147 C148 C149 C166 C167 C168 C169 C235 C236 C255 C256	Ceramic 10nF / 100V / 20% X7R 0805 Capacitor	BC Components	0805B103M101NT
3	C903 C957 C959	Ceramic 10nF / 50V / 20% X7R 0805 Capacitor	BC Components	0805B103M500NT
3	C902 C956 C958	Ceramic 100nF / 50V / 20% X7R 0805 Capacitor	BC Components	0805B104M500NT
8	C107 C108 C109 C110 C207 C208 C209 C210	Ceramic 33nF / 50V / 20% X7R 0805 Capacitor	BC Components	0805B333M500NT
8	C123 C125 C127 C129 C223 C225 C227 C229	Ceramic 1uF / 100V / 10% X7R 1210 Capacitor	Murata	GRM32ER72A105KA01L
8	C150 C151 C170 C171 C237 C238 C257 C258	Ceramic 1nF / 100V / 10% X7R 0603 Capacitor	Murata	GRM188R72A102KA01
2	C10 C13	Ceramic 10nF / 50V / 20% X7R 0603 Capacitor	Vishay	VJ0603Y103MXA
26	C11 C12 C14 C17 C21 C22 C25 C60 C61 C101 C102 C104 C105 C106 C111 C201 C202 C204 C205 C206 C211 C922 C923 C980 C981	Ceramic 100nF / 16V / 20% X7R 0603 Capacitor	Vishay	VJ0603Y104MXJ
12	C113 C115 C117 C119 C213 C215 C217 C219 C233 C234 C253 C254	Ceramic 100nF / 100V / 10% X7R 0603 Capacitor	Murata	GRM188R72A104KA35D
5	C20 C180 C181 C182 C183	Electrolytic 10uF / 16V / 20% Aluminium 1.5mm ø4mm Ultra-Mini Series Capacitor	Sang Jing Electronic	UMR16V106M4X5
3	C62 C924 C925	Electrolytic 33uF / 16V / 20% Aluminium 2mm ø5mm Capacitor	Panasonic	ECEA1CKA330
10	C140 C141 C142 C143 C160 C161 C162 C163 C272 C274	Electrolytic 470uF / 35V / 20% Aluminium 5mm ø10mm FC Series - Low Impedance Capacitor	Panasonic	EEUFC1V471
4	C144 C145 C164 C165	Metal Film 1uF / 50V / 10% Polyester 7.5mm (W:4.5mm L:10mm) Capacitor	Wima	MKS 4 1uF/10%/50Vdc PCM7.5
2	C232 C252	Metal Film 470nF / 63V / 10% Polyester 7.5mm (W:4.5mm L:10mm) Capacitor	Wima	MKS 4 0.47uF/10%/63Vdc PCM7.5
4	L230 L231 L250 L251	10uH / Ferrite Inductor	Kwang Sung	8019P-23-100L
4	L130 L131 L150 L151	20uH / Ferrite Inductor	Kwang Sung	8020P-01-200L
2	D10 D11	Light Emitting Red Red LED (0603) 600mA / 40V NPN Small signal PMBT2222	Toshiba	TLSU1008
1	Q981	Transistor (SOT-23)	Philips	PMBT2222
10	Q180 Q181 Q182 Q183 Q184 Q185 Q186 Q187 Q980 Q982	800mA / 40V PNP Small signal MMBT2907A Transistor (SOT-23)	Fairchild	MMBT2907A
1	U10	TAS5086DBT / 6 ch PWM processor (SE, VOL, 192kHz, I2S out) (TSSOP38)	Texas Instruments	TAS5086DBT
2	U100 U200	TAS5342LDDV / STEREO DIGITAL AMPLIFIER POWER STAGE (DDV44)	Texas Instruments	TAS5342LDDV
1	U908	TPS3801K33 / 3.3V Supply Voltage Supervisor (SOT323-5)	Texas Instruments	TPS3801K33DCK
1	U907	TLV1117-33C / 3.3V/800mA Positive Voltage Regulator (SOT4-DCY)	Texas Instruments	TLV1117-33CDCYR
4	SCREW620 SCREW621 SCREW622 SCREW623	M3x6 Pan Head, Pozidriv, A2 Screw	Bossard	BN 81882 M3x6
4	SCREW630 SCREW631 SCREW632 SCREW633	M3x8 Pan Head, Pozidriv, A2 Screw	Bossard	BN 81882 M3x8
4	WASHER620 WASHER621 WASHER622 WASHER623	M3 Stainless Steel Washer	Bossard	BN 670 M3
4	WASHER630 WASHER631 WASHER632 WASHER633	M3 Stainless Steel Spring Washer	Bossard	BN 760 M3
4	STANDOFF620 STANDOFF621 STANDOFF622 STANDOFF623	M3x10 Aluminium Stand-off	Ettinger	05.03.108
6	J101 J102 J103 J104 J105 J106	2 pins / 1 row / 3.96mm Pitch Vertical Male Pin header Header	JST	B2P-VH
1	J901	4 pins / 1 row / 3.96mm Pitch Vertical Male Pin header Header	JST	B4P-VH

TAS5342LDDV6EVM Partslist (2.00)



1	J10	26 pins / 2 rows / 2.54mm Pitch Vertical Male Low profile IDC 26 pins IDC Box header	Molex	87834-2611
1	PCB610	A833-PCB-001_1.00 / TAS5342LDDV6EVM Printed Circuit Board (ver. 1.00)	Printline	A833-PCB-001(1.00)
1	HEATSINK630	TIC-HSINK-058_1.00 / Heatsink for 2 DDV packages length 90 mm	Phonotech	TIC-HSINK-058(1.00)

TAS5342LDDV6EVM

PCB SPECIFICATION

Version 1.00

BOARD IDENTIFICATION:	A833-PCB-001(1.00)
BOARD TYPE:	DOUBLE-SIDED PLATED-THROUGH BOARD
LAMINATE TYPE:	FR4
LAMINATE THICKNESS:	1.6mm
COPPER THICKNESS:	70 μm (INCL. PLATING EXTERIOR LAYER)
COPPER PLATING OF HOLES:	>25 μm
MINIMUM HOLE DIAMETER	0.3 mm
SILKSCREEN COMPONENT SIDE:	WHITE - REMOVE SILKSCREEN FROM SOLDER AREA & PRE-TINNED AREAS
SILKSCREEN SOLDER SIDE:	None
SOLDER MASK COMPONENT SIDE:	GREEN
SOLDER MASK SOLDER SIDE:	GREEN
PROTECTIVE COATING:	SOLDER COATING AND CHEMICAL SILVER ON FREE COPPER
ELECTRICAL TEST:	PCB MUST BE ELECTRICAL TESTED
MANUFACTURED TO:	PERFAG 2E (www.perfag.dk)
APERTURE TABLE:	PERFAG 10A (www.perfag.dk)
BOARD SIZE:	112 x 154 mm
Aprox. Number of holes	600
COMMENTS:	SEE DRILL INFORMATION FILE (5288pcb.PDF).

COMPONENT SIDE

Dps 5288 071205

TI Denmark A833-PCB-001 (1.00)

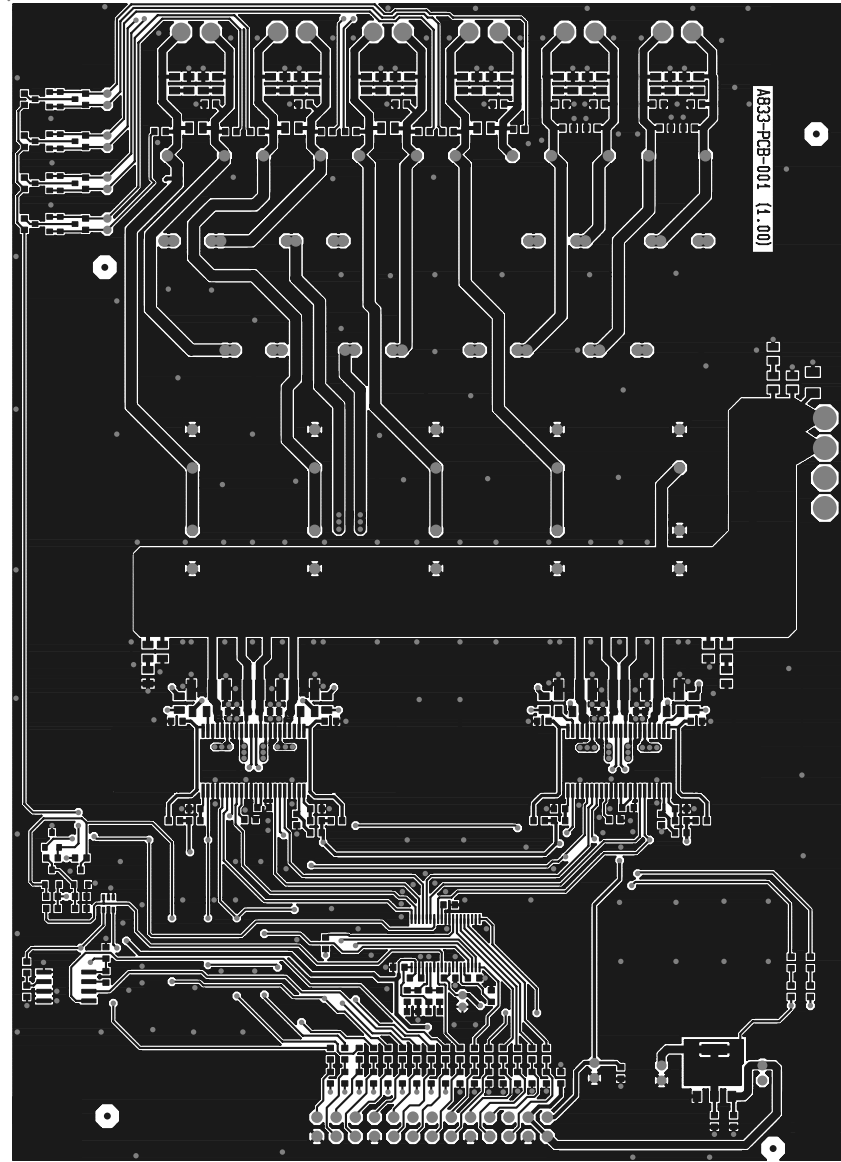

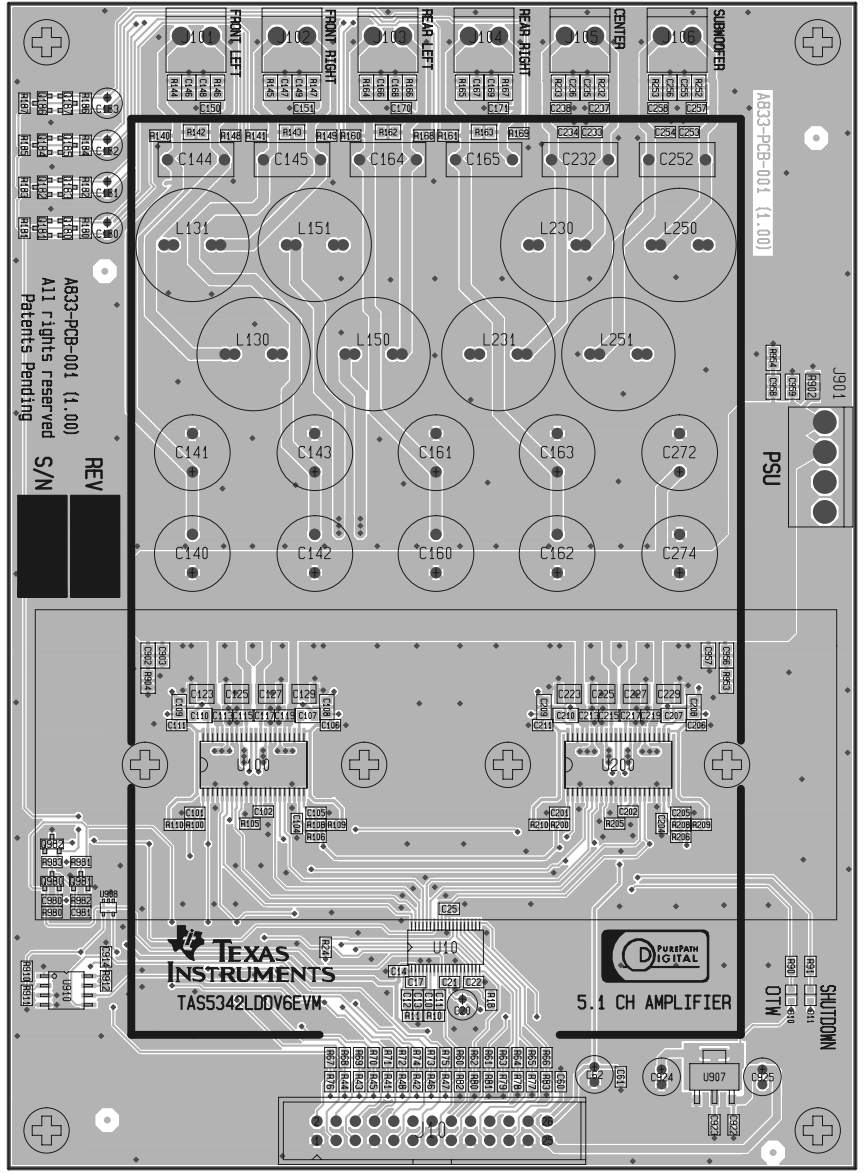

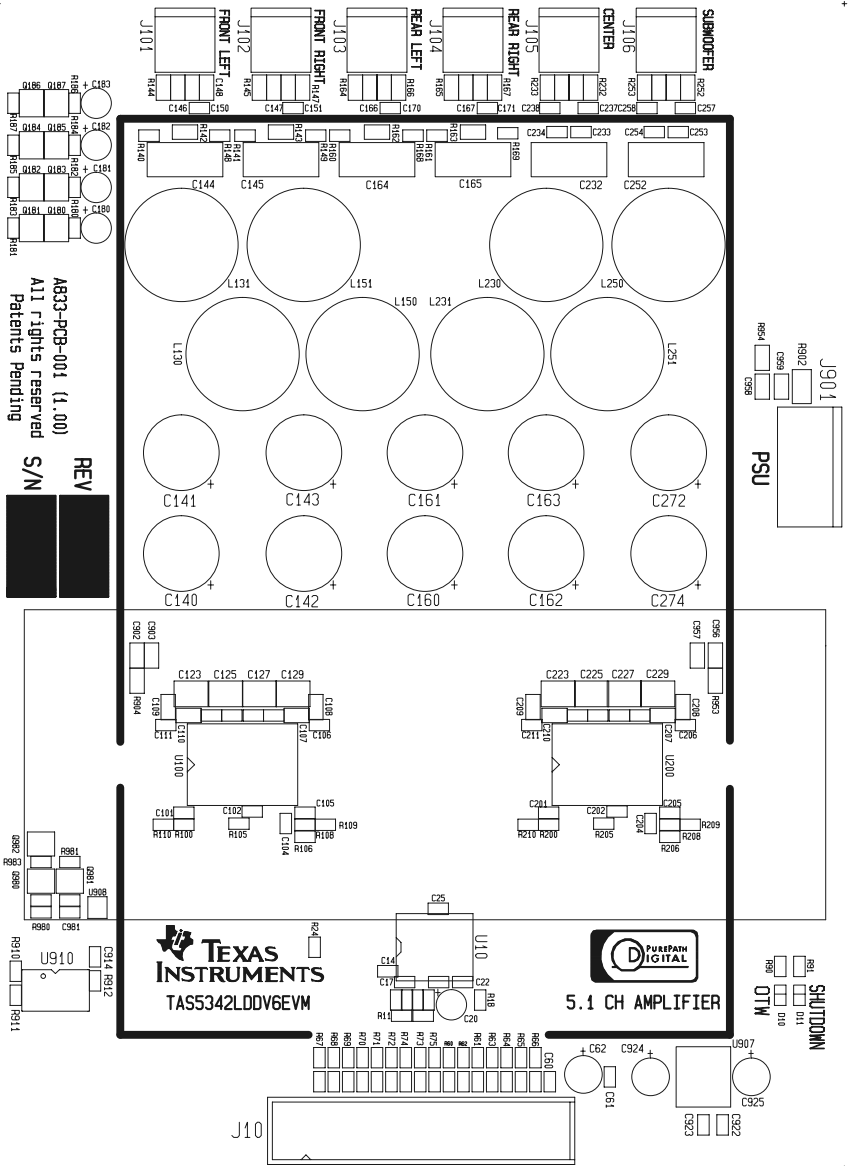

A833-PCB-001 (1.00)
 All rights reserved
 Patents Pending

REV
 S/N

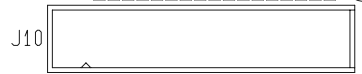
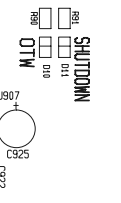
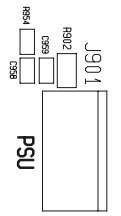

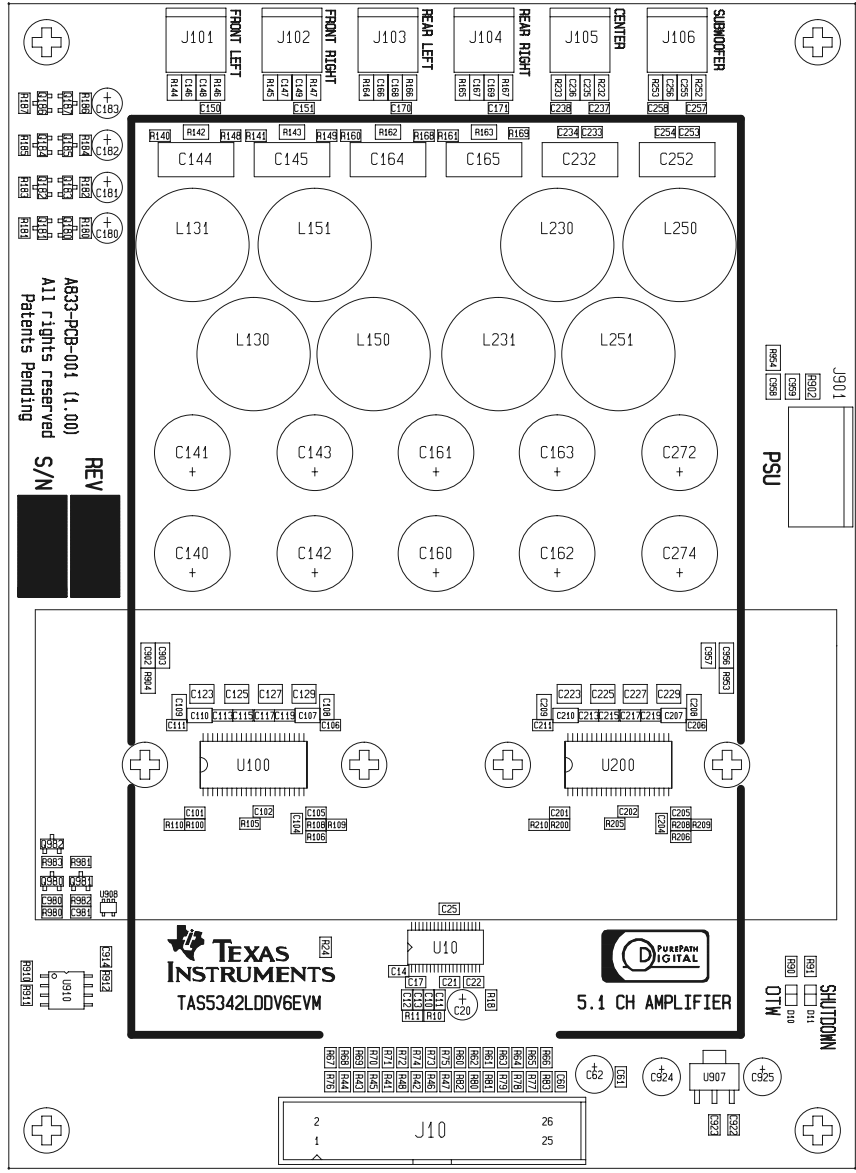

A833-PCB-001 (1.00)
 All rights reserved
 Patents Pending

REV
 S/N

TEXAS INSTRUMENTS
 TAS5342LDDV6EVM

PUREPATH DIGITAL
 5.1 CH AMPLIFIER

SHUTDOWN
 010
 011
 012

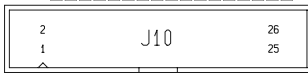

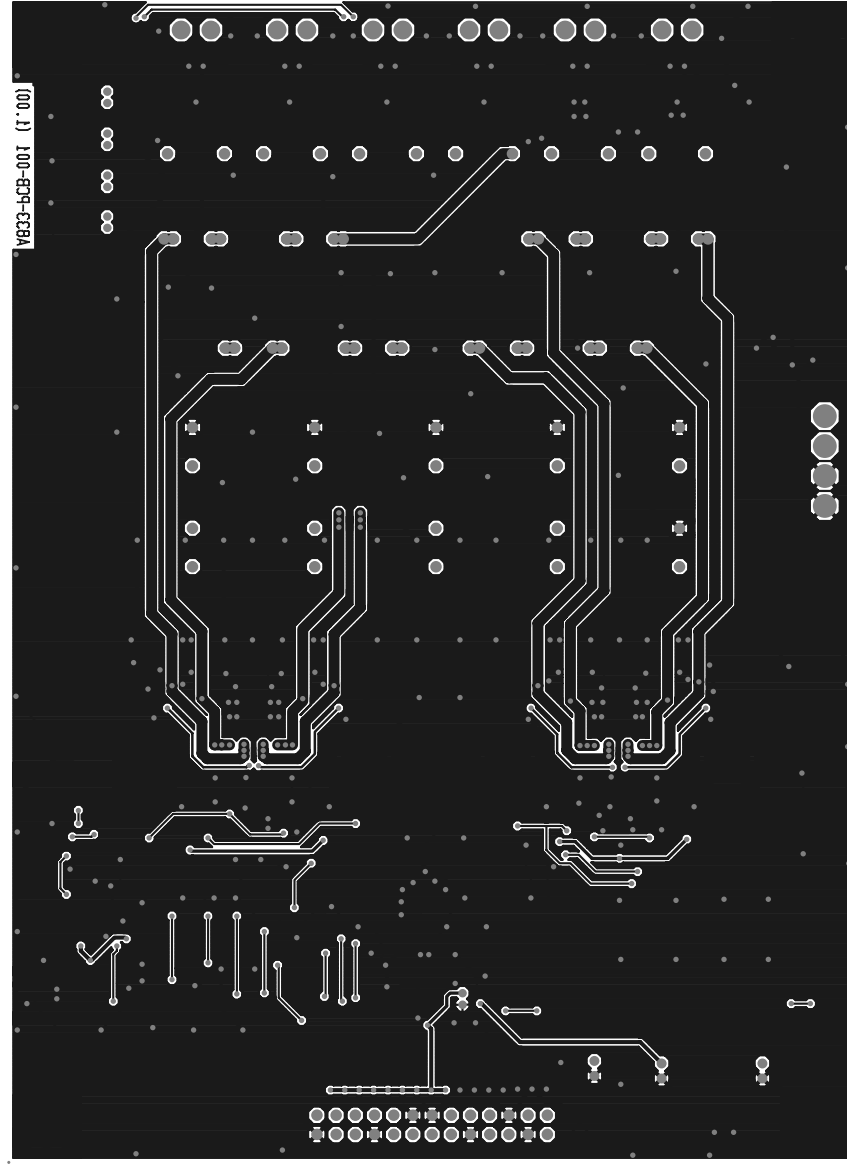

A833-PCB-001 (1.00)

TIC-HSINK-058(1.00)

Heatsink for 2 DDV packages length 90 mm

10.January 2008
TIC-HSINK-058(1.00).dwg

Jonas L. Holm

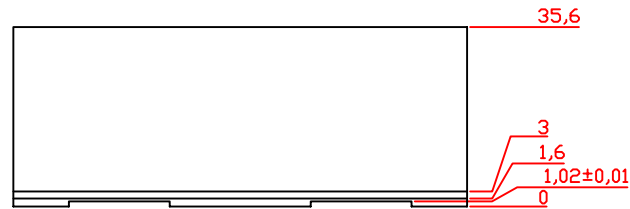
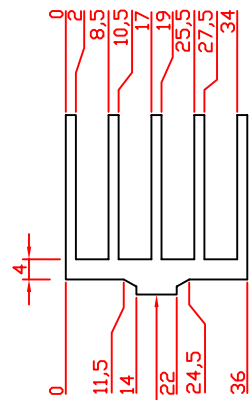
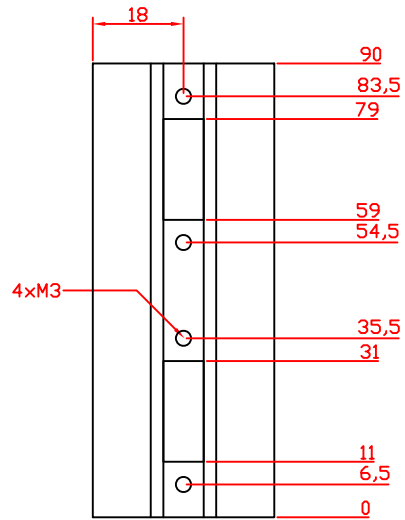

Machine this edge afte anodizing

SCALE: 1:1.5
 PROFILE: TIC-HSINK-041(1.00)
 DIMENSIONS: mm
 MATERIAL: ALUMINUM
 INTERNAL SCREW THREADS: M3
 SURFACE: FREE OF SHARP EDGES
 SURFACE TREATMENT: BLACK ANODIZED
 TOLERANCES: +/- 0.1 mm

IMPORTANT NOTICE

Texas Instruments Incorporated and its subsidiaries (TI) reserve the right to make corrections, modifications, enhancements, improvements, and other changes to its products and services at any time and to discontinue any product or service without notice. Customers should obtain the latest relevant information before placing orders and should verify that such information is current and complete. All products are sold subject to TI's terms and conditions of sale supplied at the time of order acknowledgment.

TI warrants performance of its hardware products to the specifications applicable at the time of sale in accordance with TI's standard warranty. Testing and other quality control techniques are used to the extent TI deems necessary to support this warranty. Except where mandated by government requirements, testing of all parameters of each product is not necessarily performed.

TI assumes no liability for applications assistance or customer product design. Customers are responsible for their products and applications using TI components. To minimize the risks associated with customer products and applications, customers should provide adequate design and operating safeguards.

TI does not warrant or represent that any license, either express or implied, is granted under any TI patent right, copyright, mask work right, or other TI intellectual property right relating to any combination, machine, or process in which TI products or services are used. Information published by TI regarding third-party products or services does not constitute a license from TI to use such products or services or a warranty or endorsement thereof. Use of such information may require a license from a third party under the patents or other intellectual property of the third party, or a license from TI under the patents or other intellectual property of TI.

Reproduction of TI information in TI data books or data sheets is permissible only if reproduction is without alteration and is accompanied by all associated warranties, conditions, limitations, and notices. Reproduction of this information with alteration is an unfair and deceptive business practice. TI is not responsible or liable for such altered documentation. Information of third parties may be subject to additional restrictions.

Resale of TI products or services with statements different from or beyond the parameters stated by TI for that product or service voids all express and any implied warranties for the associated TI product or service and is an unfair and deceptive business practice. TI is not responsible or liable for any such statements.

TI products are not authorized for use in safety-critical applications (such as life support) where a failure of the TI product would reasonably be expected to cause severe personal injury or death, unless officers of the parties have executed an agreement specifically governing such use. Buyers represent that they have all necessary expertise in the safety and regulatory ramifications of their applications, and acknowledge and agree that they are solely responsible for all legal, regulatory and safety-related requirements concerning their products and any use of TI products in such safety-critical applications, notwithstanding any applications-related information or support that may be provided by TI. Further, Buyers must fully indemnify TI and its representatives against any damages arising out of the use of TI products in such safety-critical applications.

TI products are neither designed nor intended for use in military/aerospace applications or environments unless the TI products are specifically designated by TI as military-grade or "enhanced plastic." Only products designated by TI as military-grade meet military specifications. Buyers acknowledge and agree that any such use of TI products which TI has not designated as military-grade is solely at the Buyer's risk, and that they are solely responsible for compliance with all legal and regulatory requirements in connection with such use.

TI products are neither designed nor intended for use in automotive applications or environments unless the specific TI products are designated by TI as compliant with ISO/TS 16949 requirements. Buyers acknowledge and agree that, if they use any non-designated products in automotive applications, TI will not be responsible for any failure to meet such requirements.

Following are URLs where you can obtain information on other Texas Instruments products and application solutions:

Products

Amplifiers	amplifier.ti.com
Data Converters	dataconverter.ti.com
DSP	dsp.ti.com
Clocks and Timers	www.ti.com/clocks
Interface	interface.ti.com
Logic	logic.ti.com
Power Mgmt	power.ti.com
Microcontrollers	microcontroller.ti.com
RFID	www.ti-rfid.com
RF/IF and ZigBee® Solutions	www.ti.com/lprf

Applications

Audio	www.ti.com/audio
Automotive	www.ti.com/automotive
Broadband	www.ti.com/broadband
Digital Control	www.ti.com/digitalcontrol
Medical	www.ti.com/medical
Military	www.ti.com/military
Optical Networking	www.ti.com/opticalnetwork
Security	www.ti.com/security
Telephony	www.ti.com/telephony
Video & Imaging	www.ti.com/video
Wireless	www.ti.com/wireless

Mailing Address: Texas Instruments, Post Office Box 655303, Dallas, Texas 75265
Copyright © 2008, Texas Instruments Incorporated